

THE DEMOCRATIC PROCESS:
VOTING

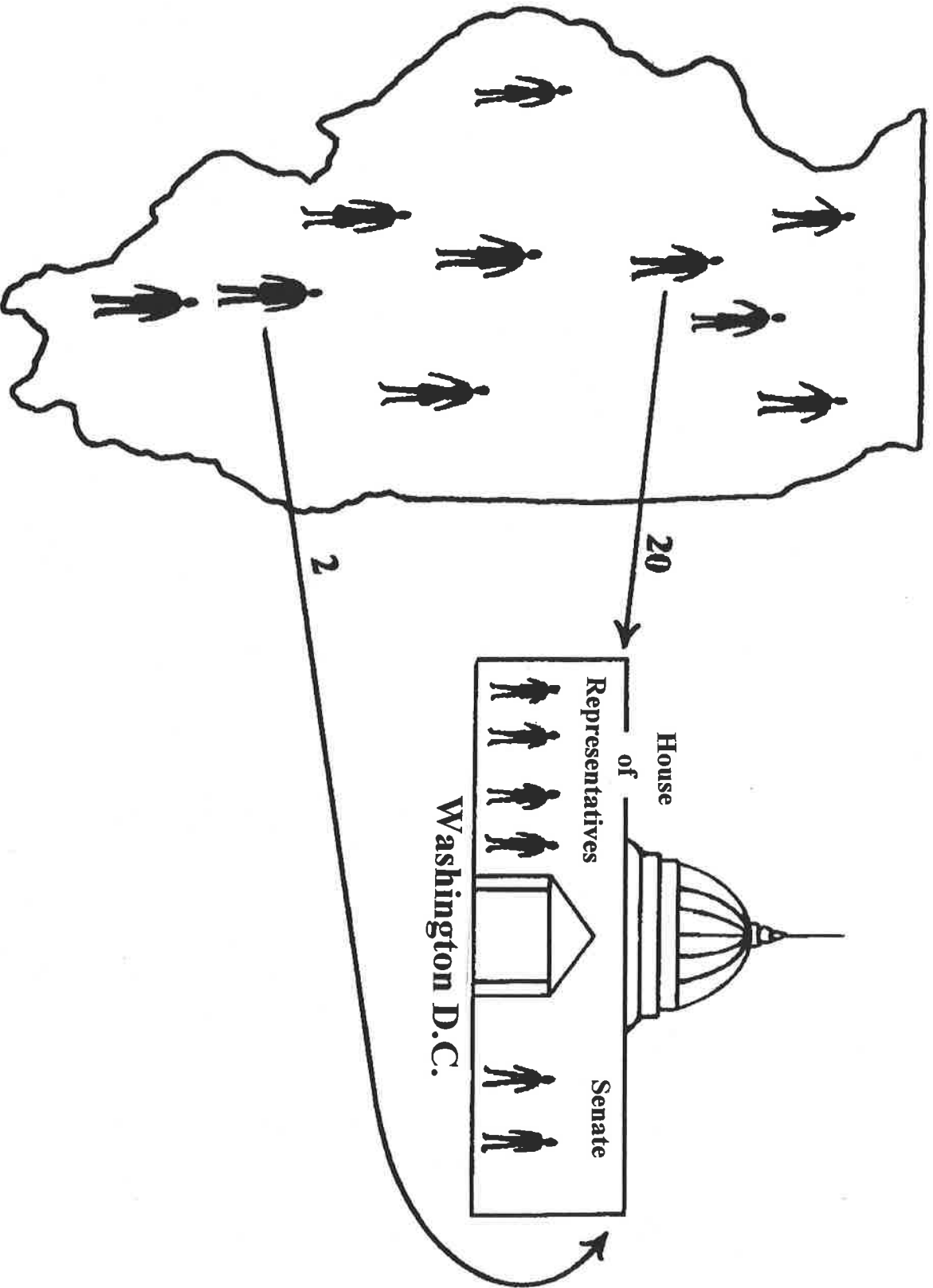

**THE DEMOCRATIC PROCESS:
VOTING**

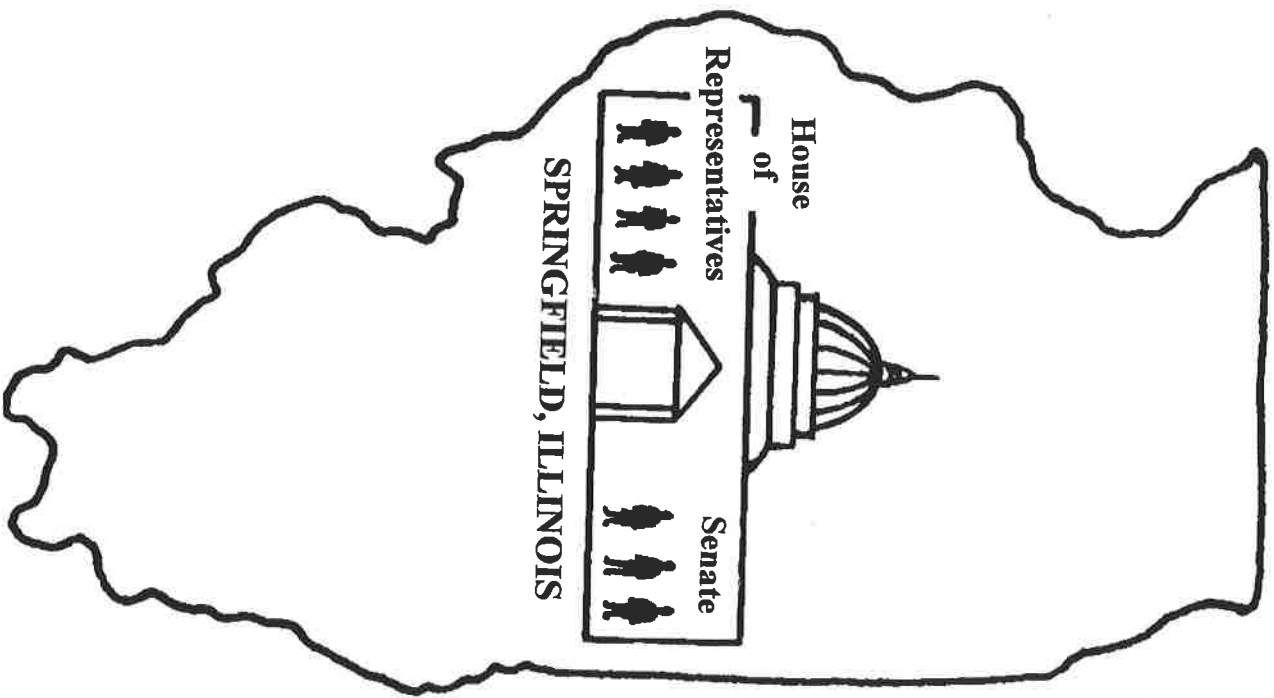

THE DEMOCRATIC PROCESS:
VOTING

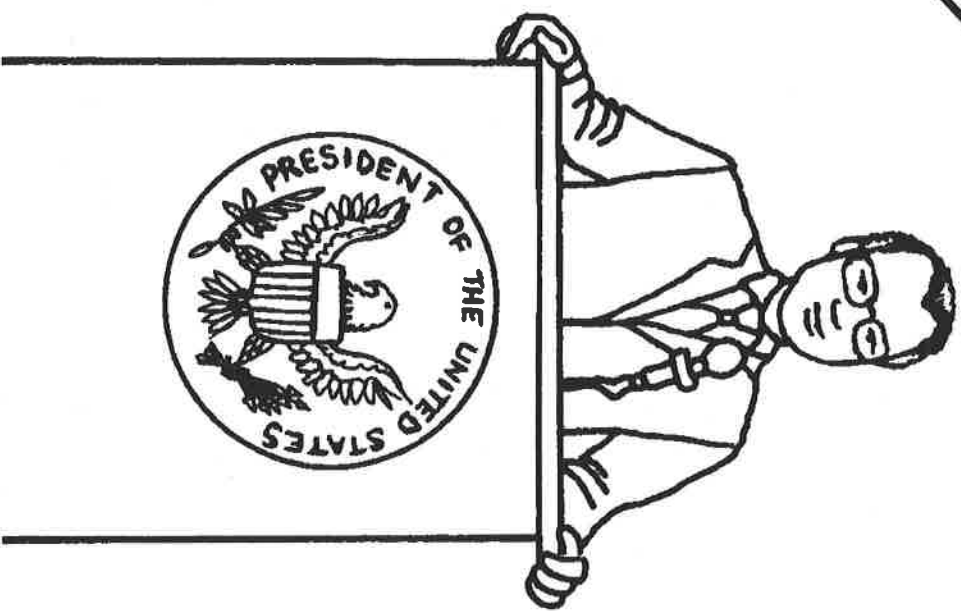

THE DEMOCRATIC PROCESS:
VOTING

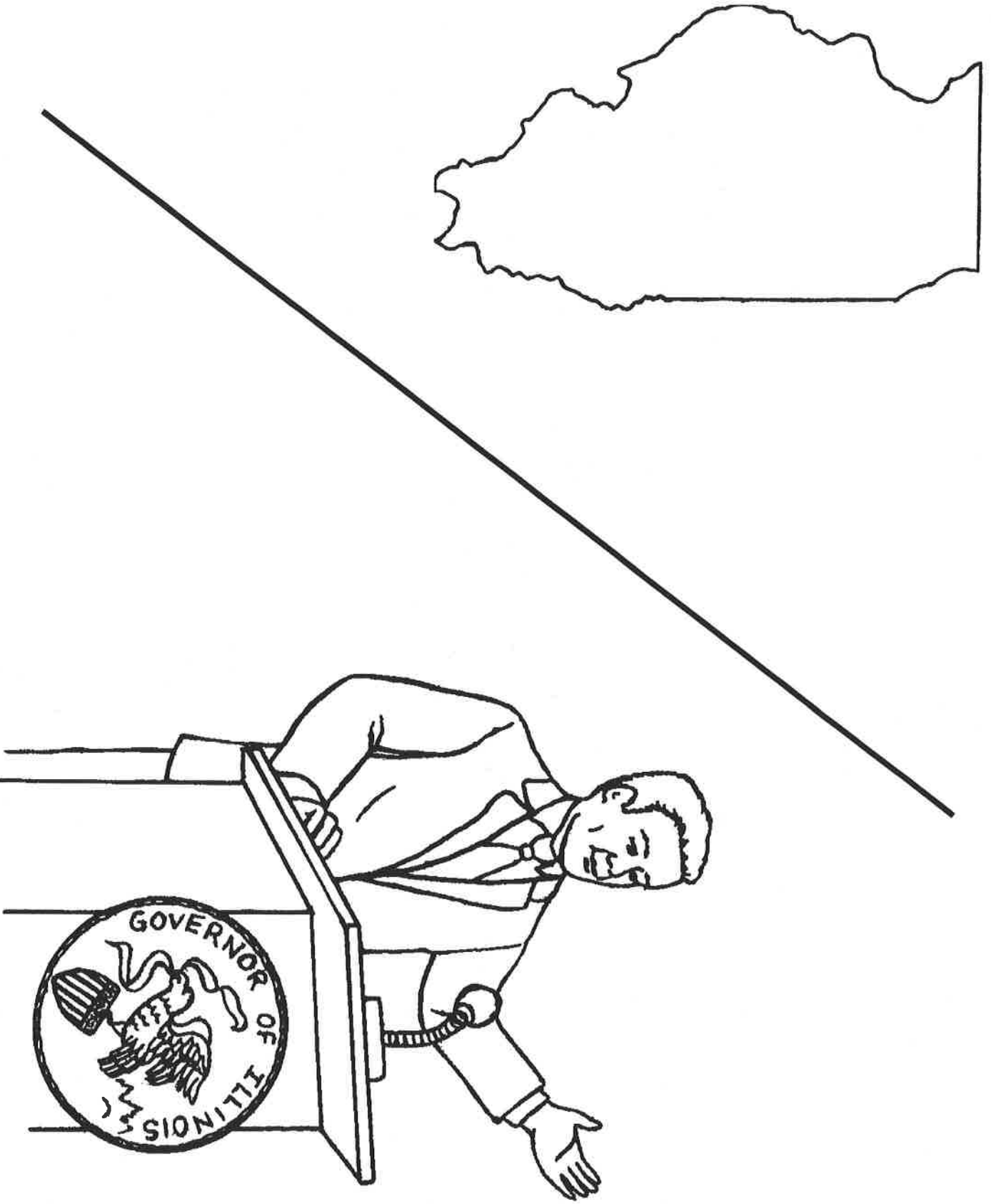

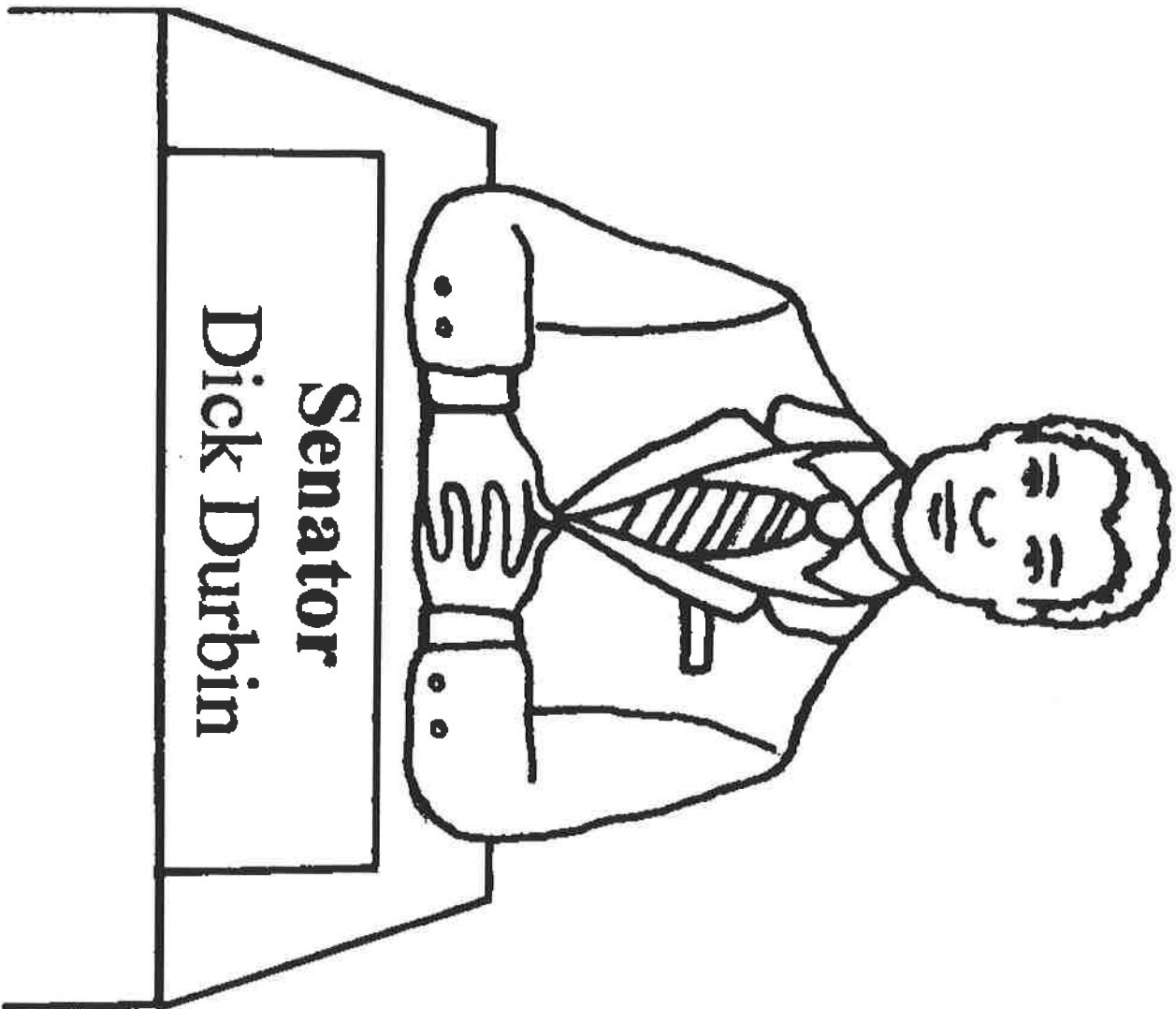

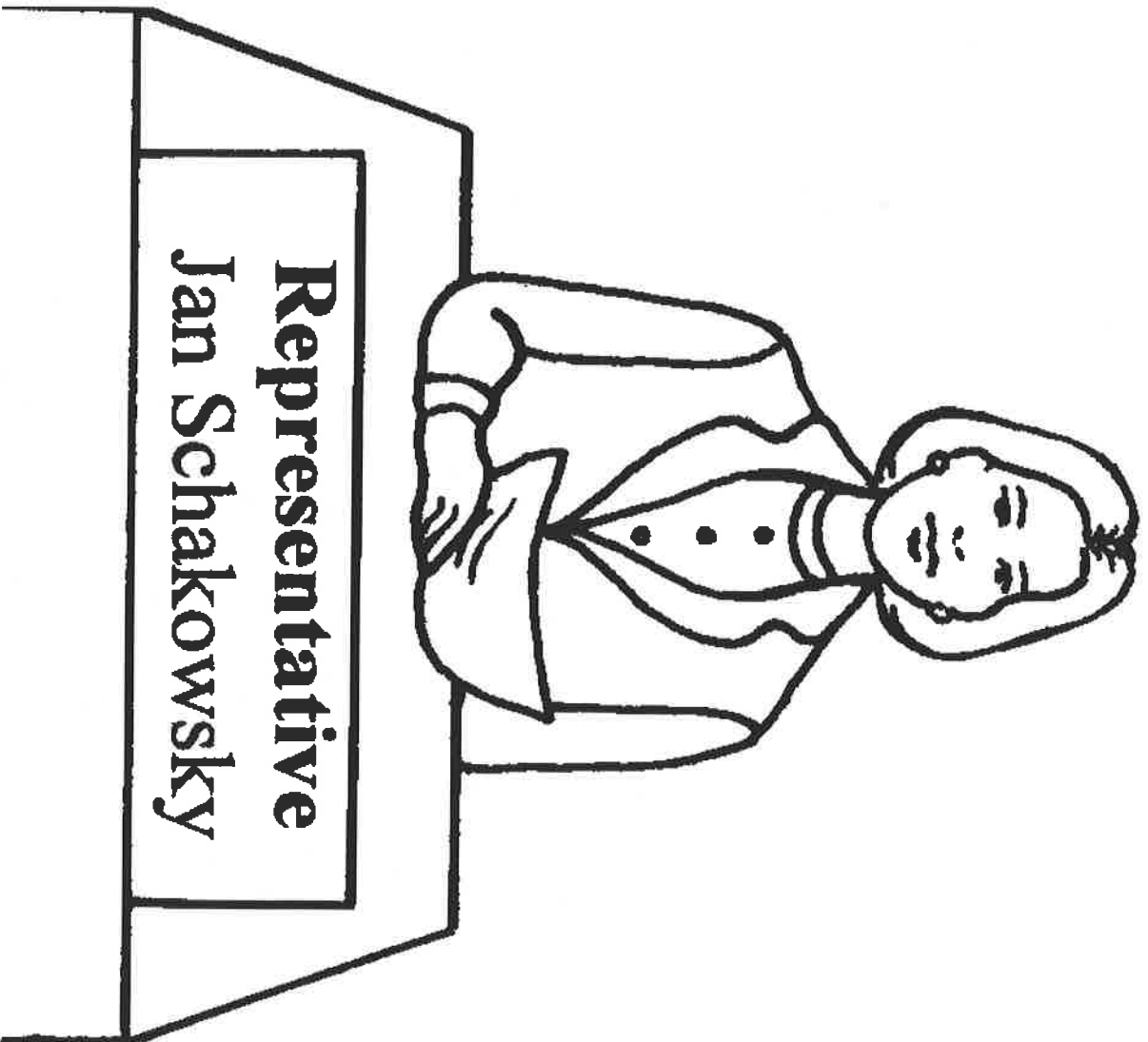

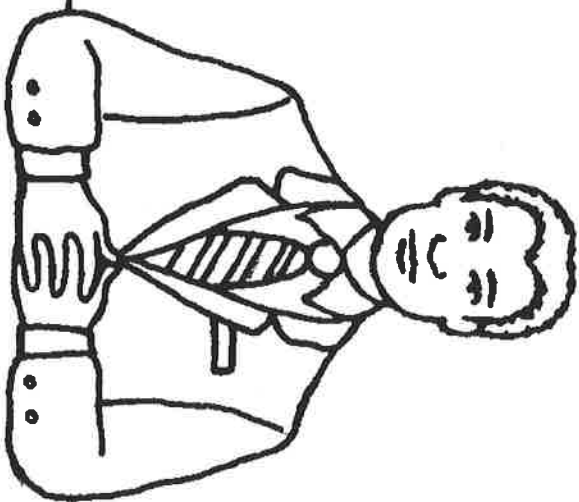

Senator
Dick Durbin

6 YEARS

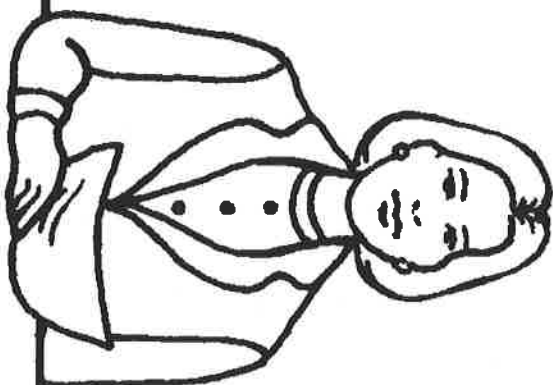

Representative
Jan Schakowsky

2 YEARS

THE DEMOCRATIC PROCESS:
VOTING

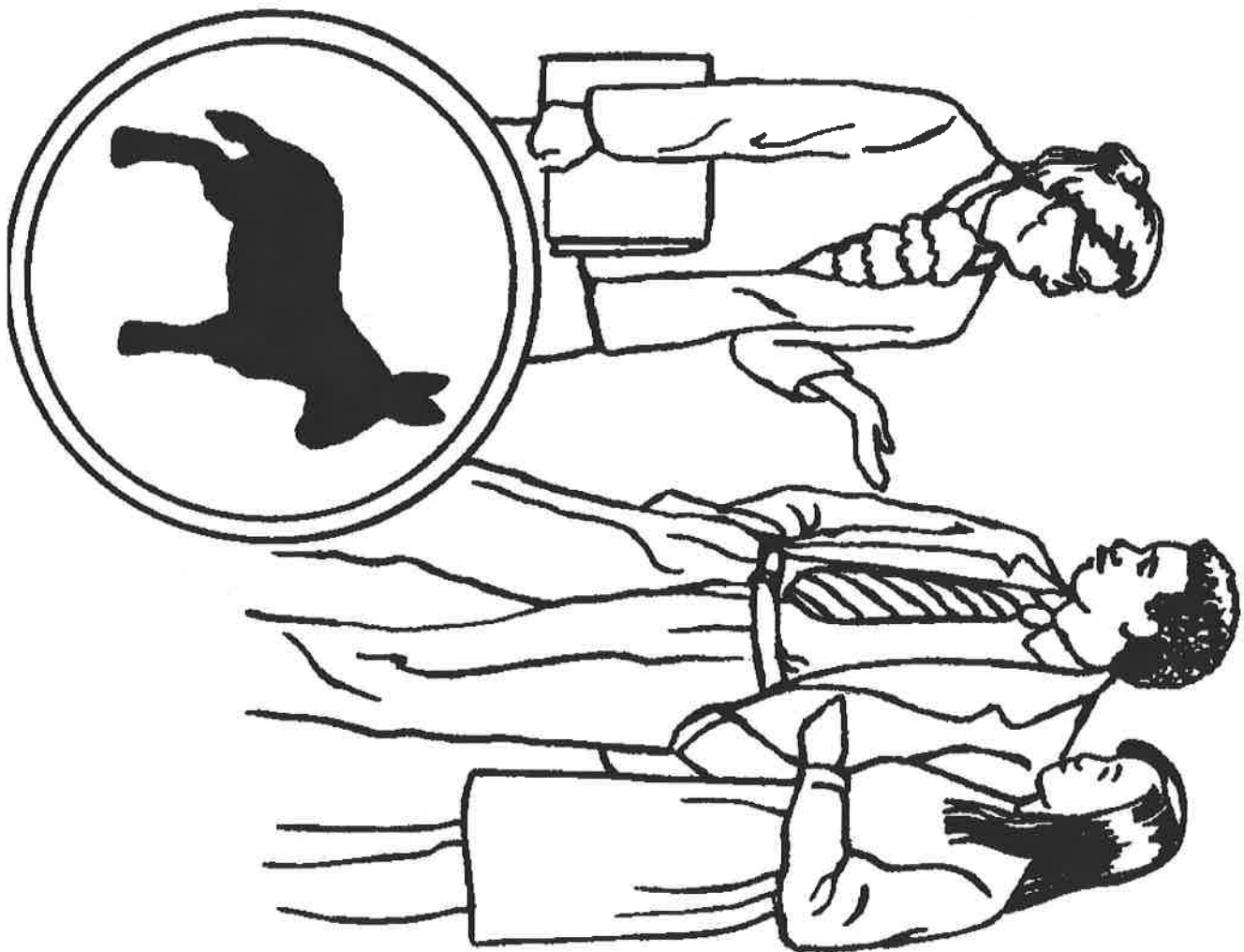

**THE DEMOCRATIC PROCESS:
VOTING**

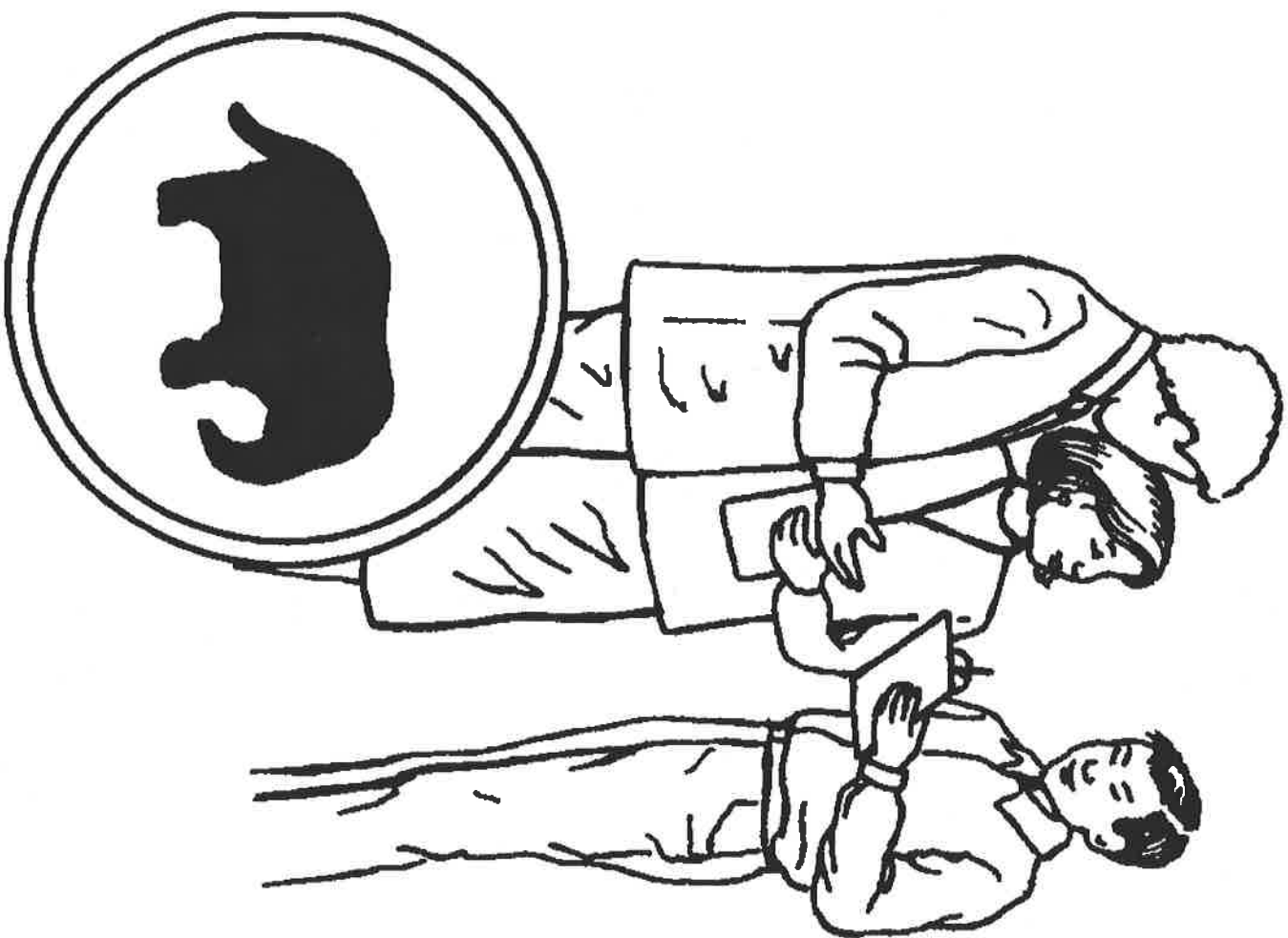



**I want
better schools!**



**No new
taxes!**

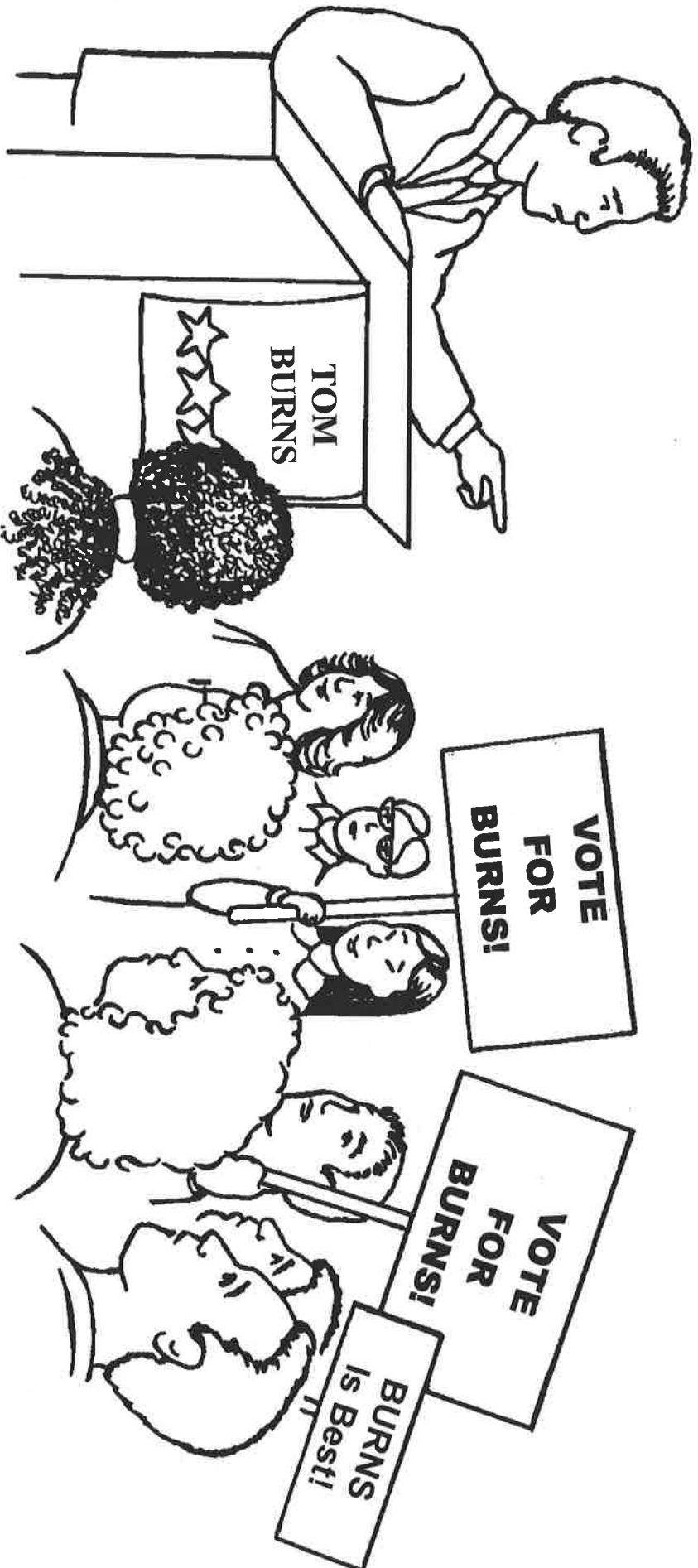

THE DEMOCRATIC PROCESS:
VOTING

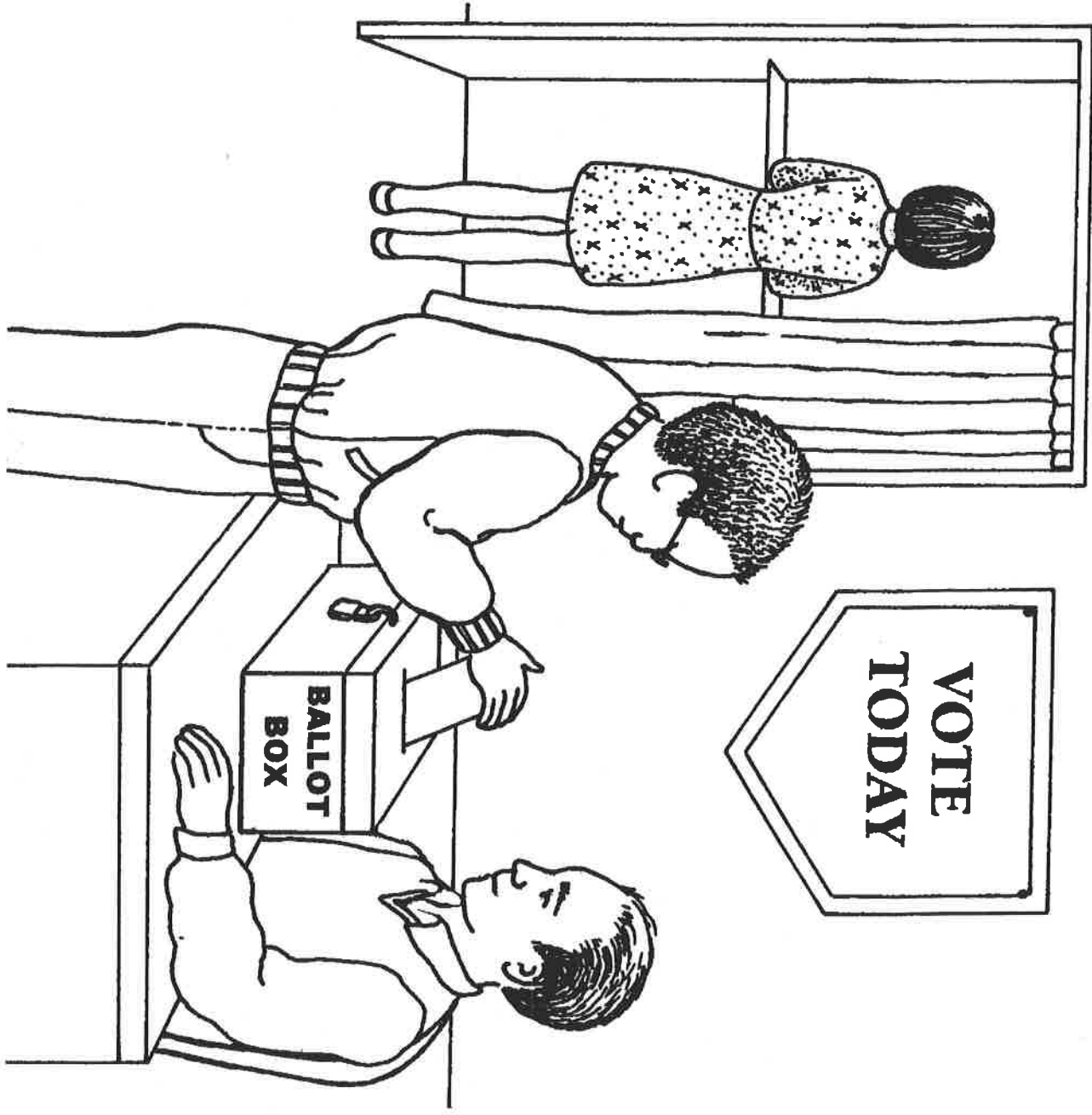

BALLOT	Punch One
CANDIDATES	
Julia Cuomo	●
Tom Burns	●
Martin Adamski	●
Sheila Rubin	●
Fred Smith	●

BALLOT
CANDIDATES
Julia Cuomo
Tom Burns
Martin Adamski
Sheila Rubin
Fred Smith

12%
63%
 5%
 15%
 5%

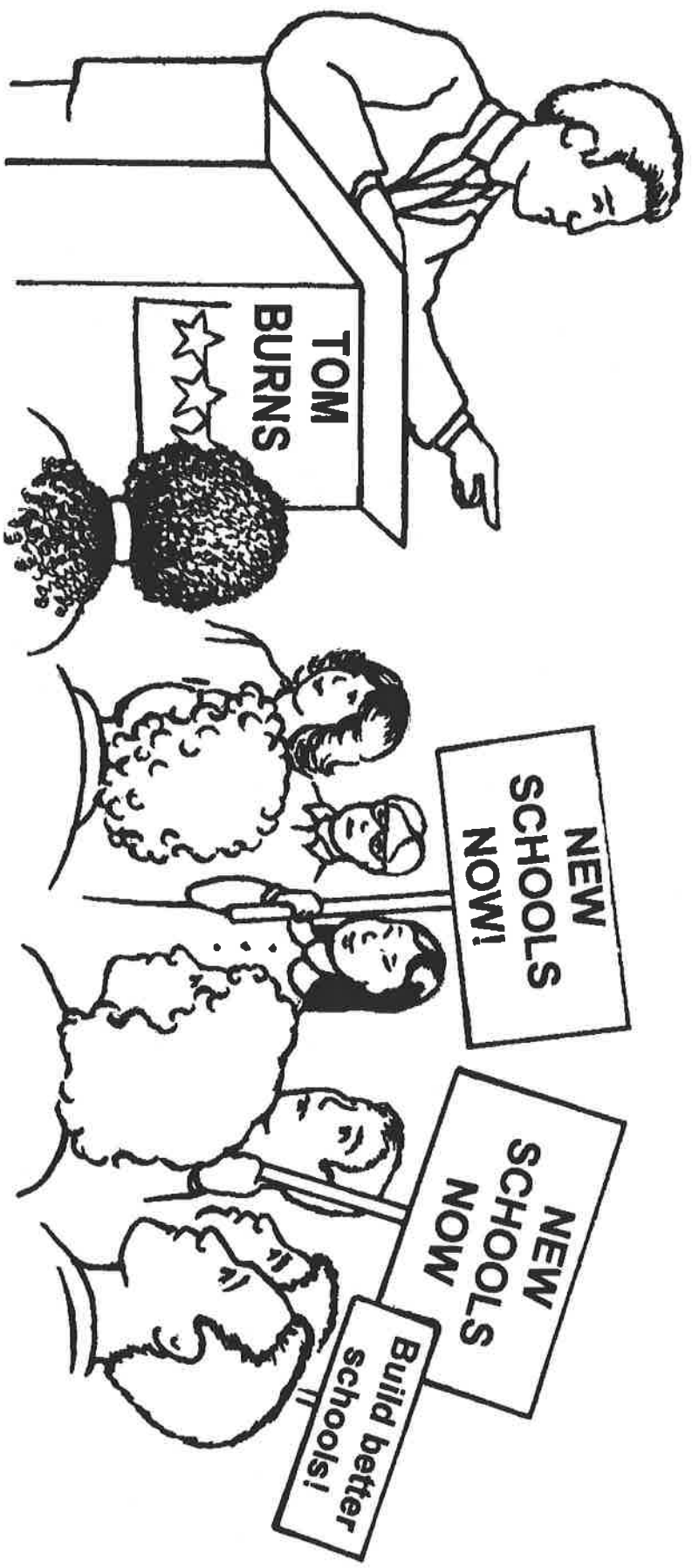

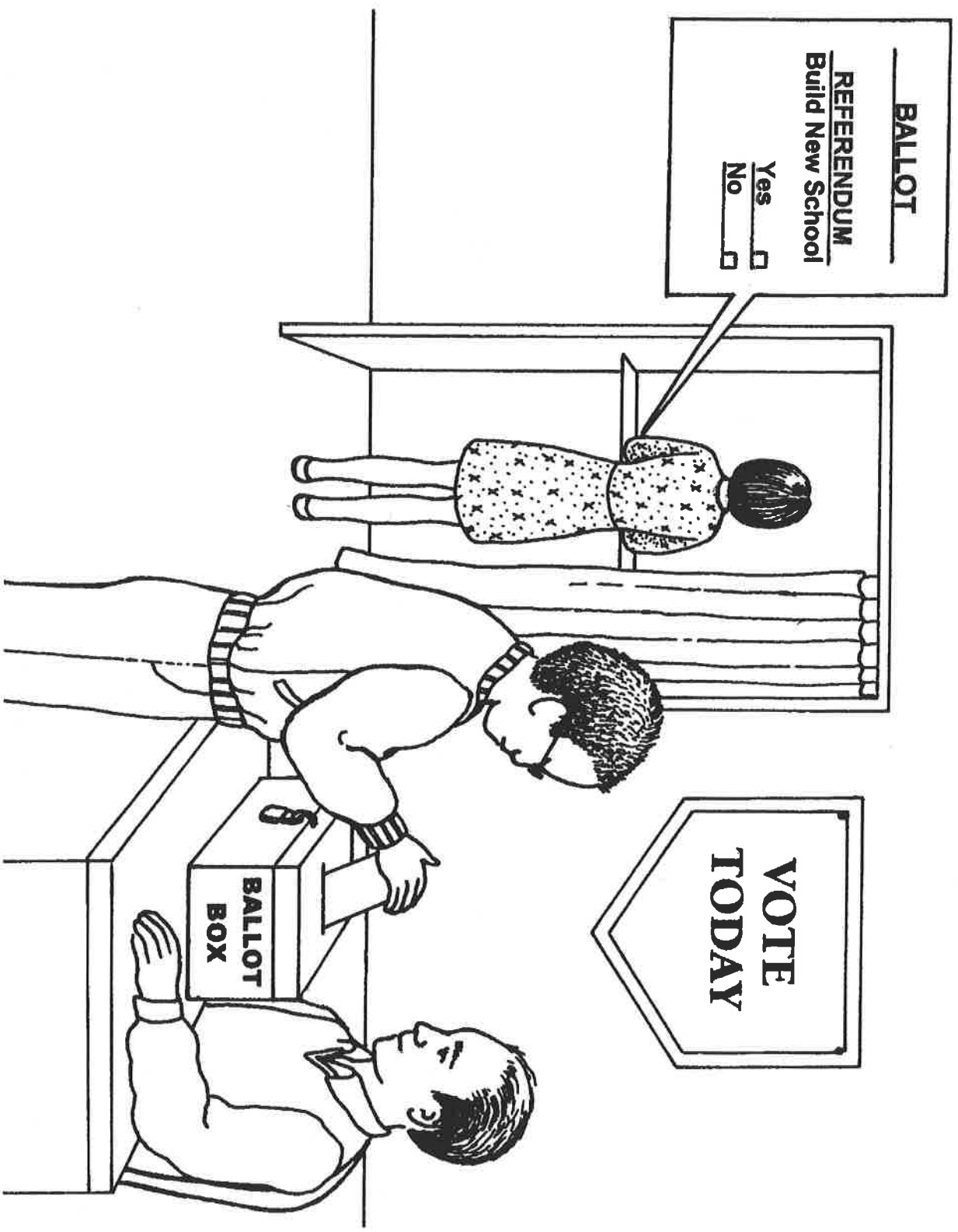

**THE DEMOCRATIC PROCESS:
VOTING**

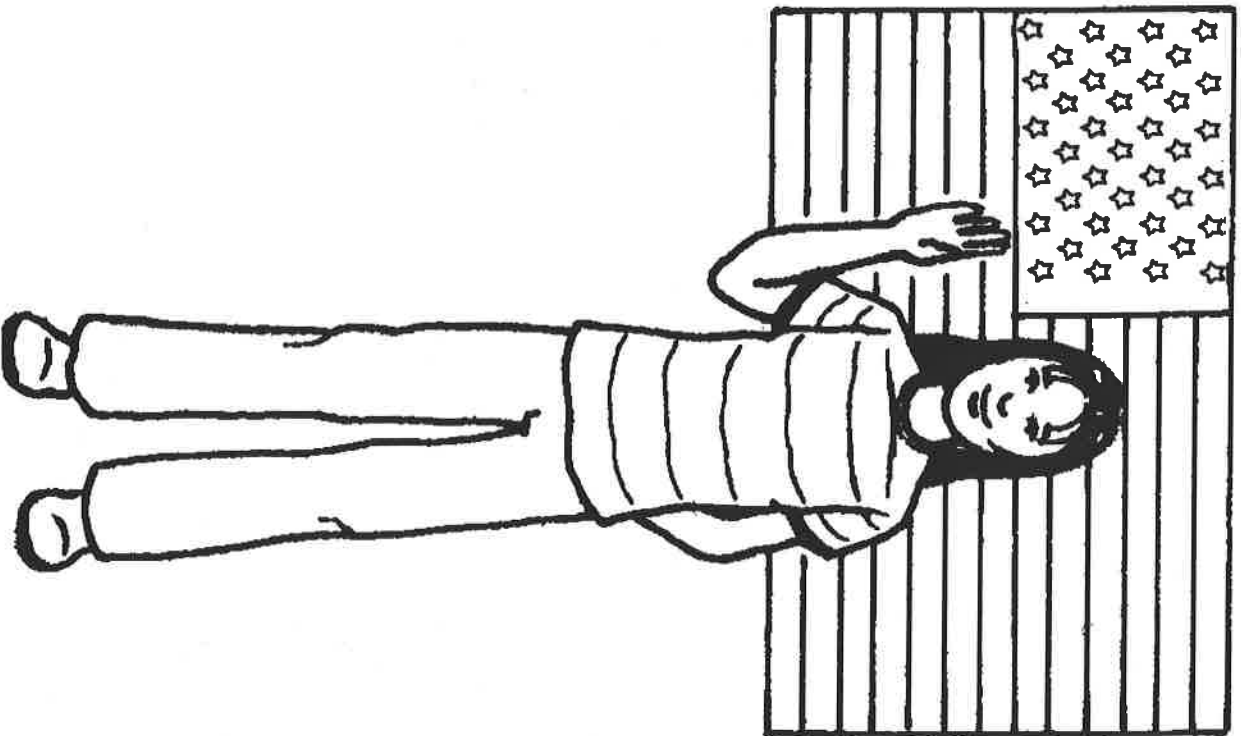

**Voter
Registration
Today**

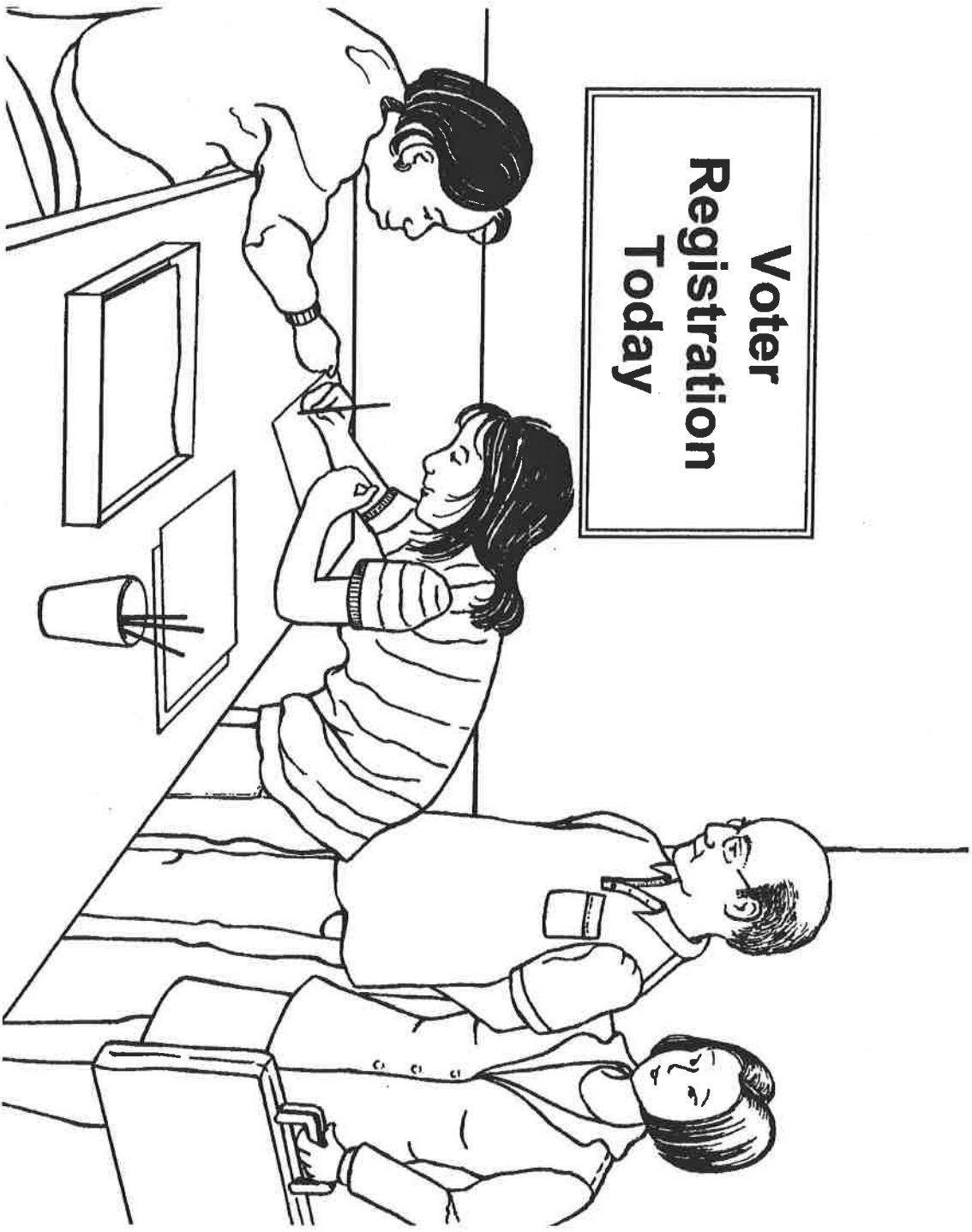

THE DEMOCRATIC PROCESS:
VOTING

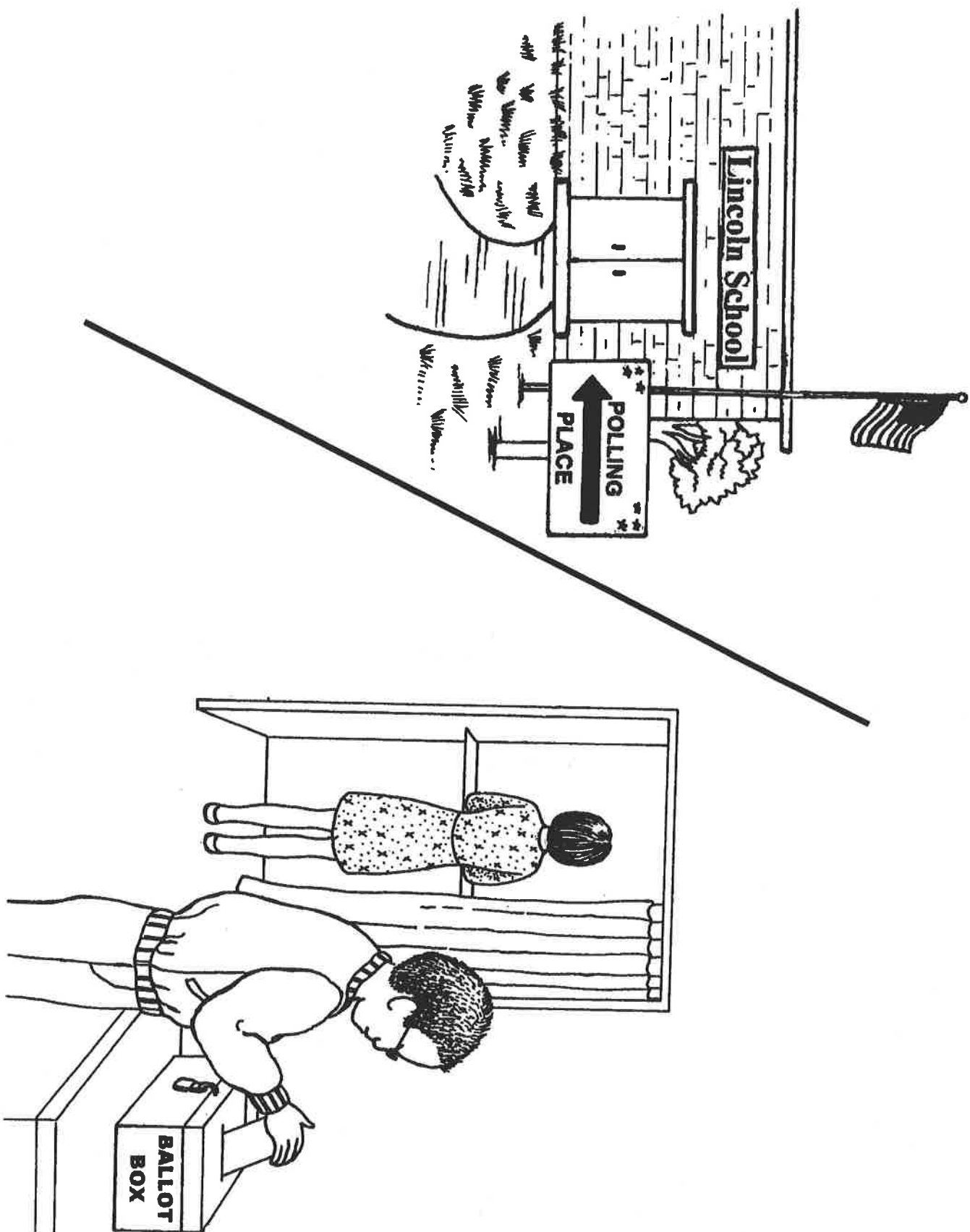



**THE DEMOCRATIC PROCESS:
VOTING**

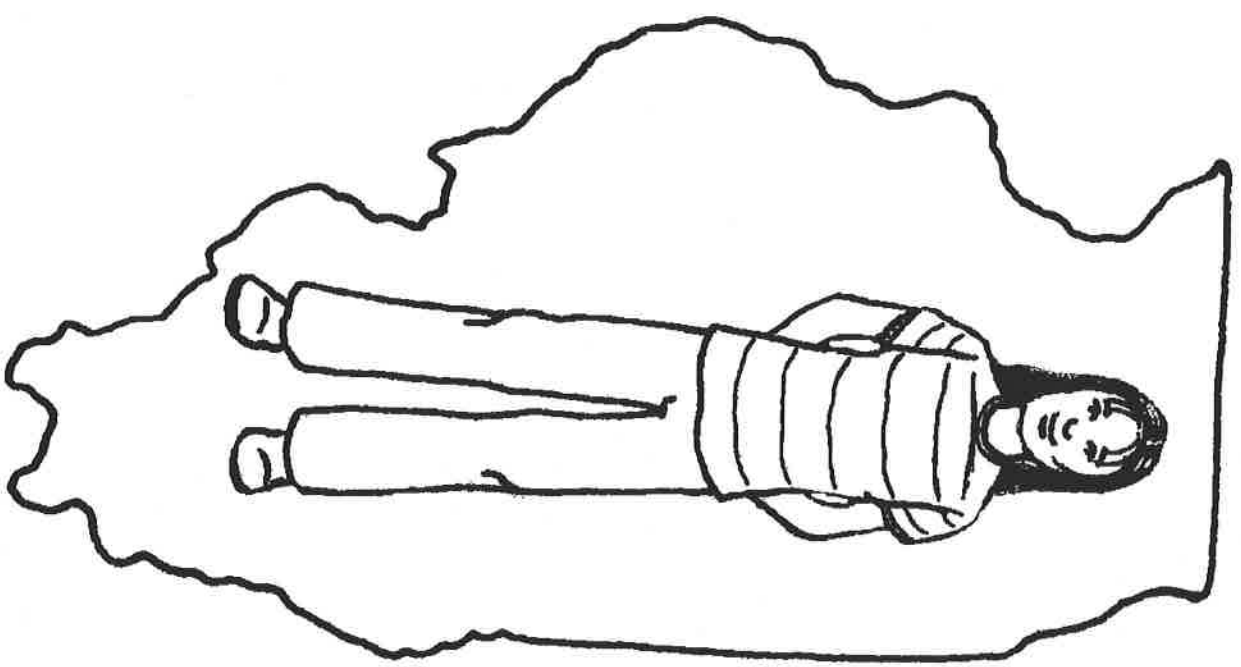

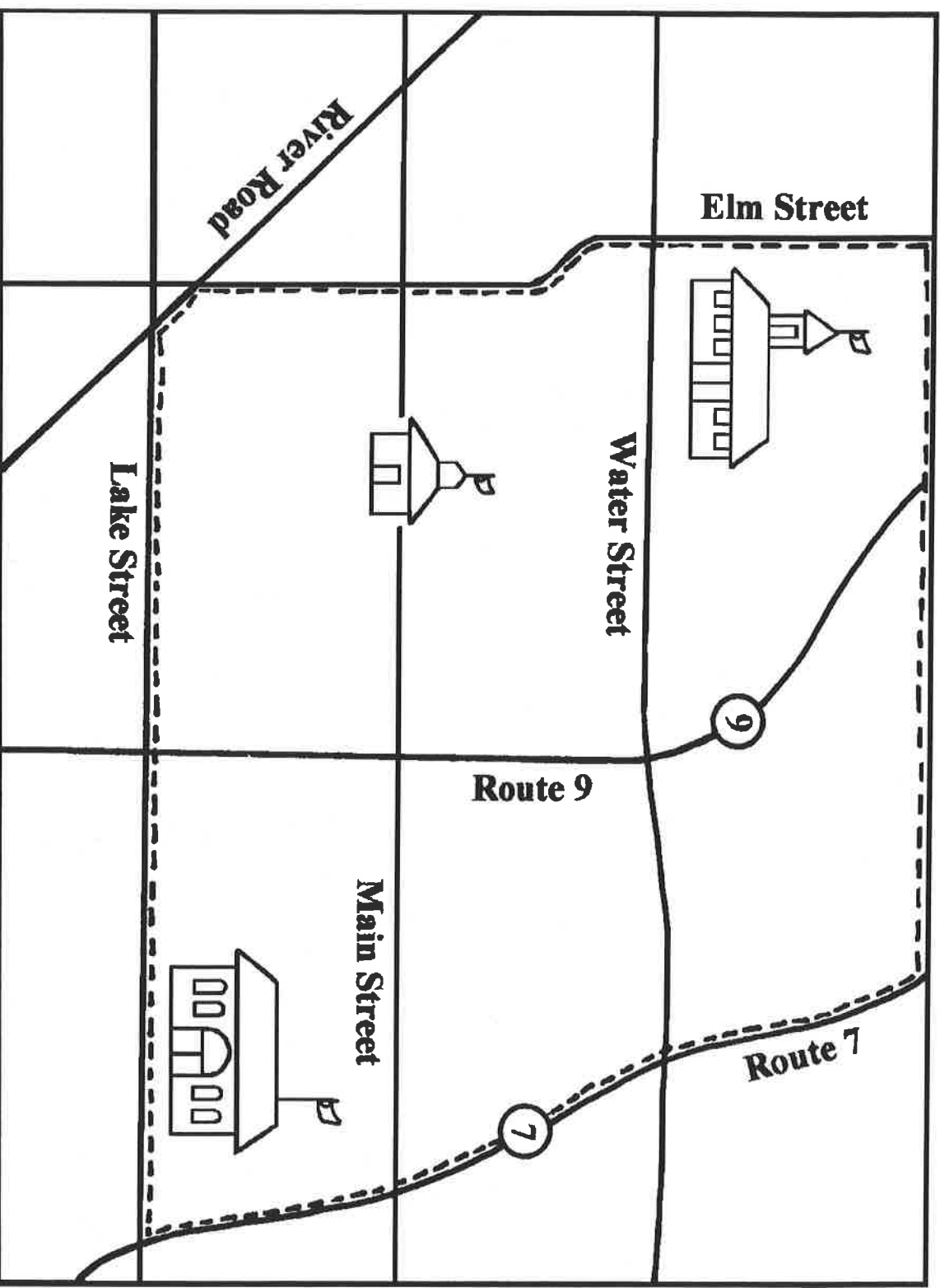

THE DEMOCRATIC PROCESS:
PARTICIPATING IN STATE AND LOCAL GOVERNMENT

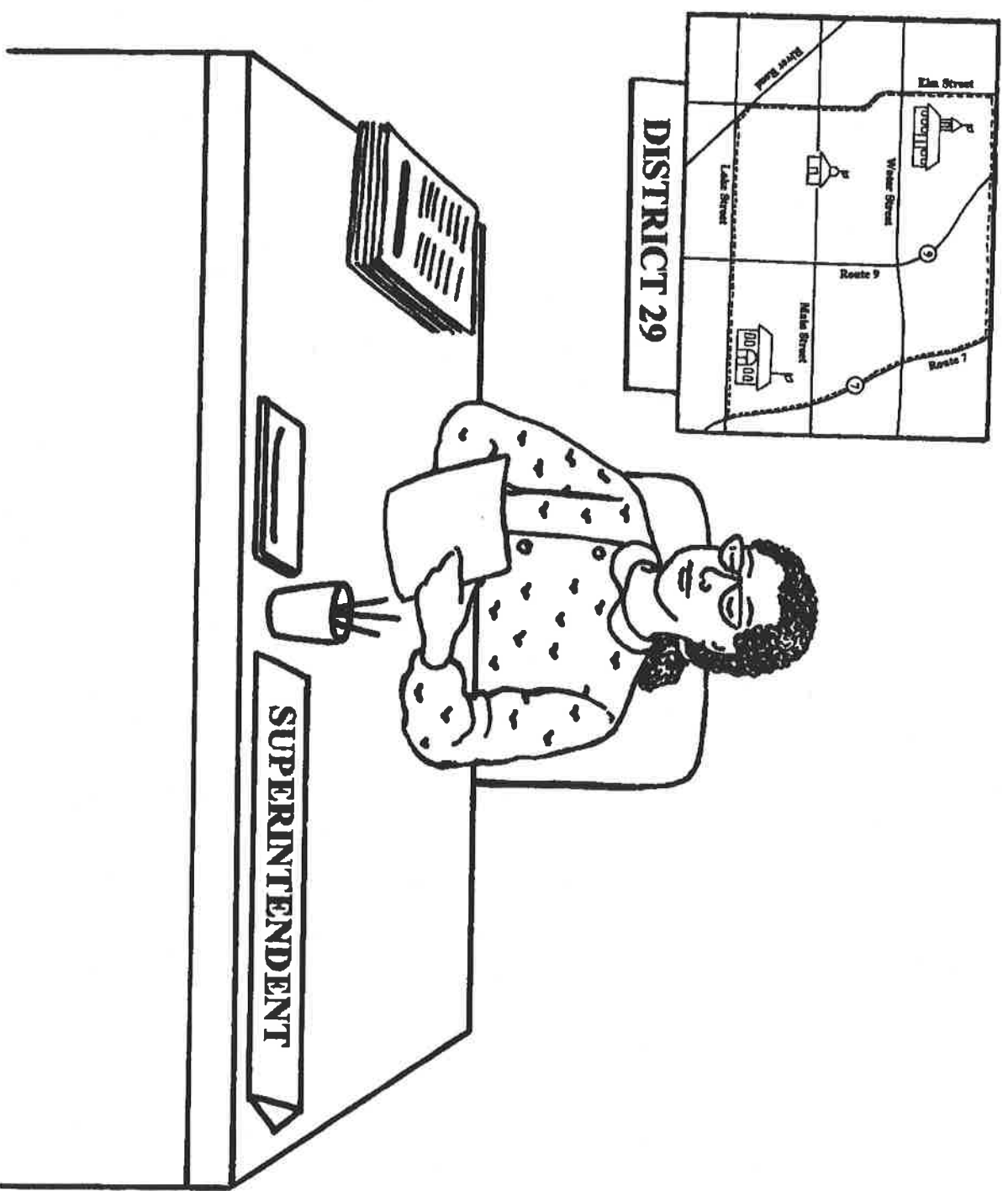

**THE DEMOCRATIC PROCESS:
PARTICIPATING IN STATE AND LOCAL GOVERNMENT**

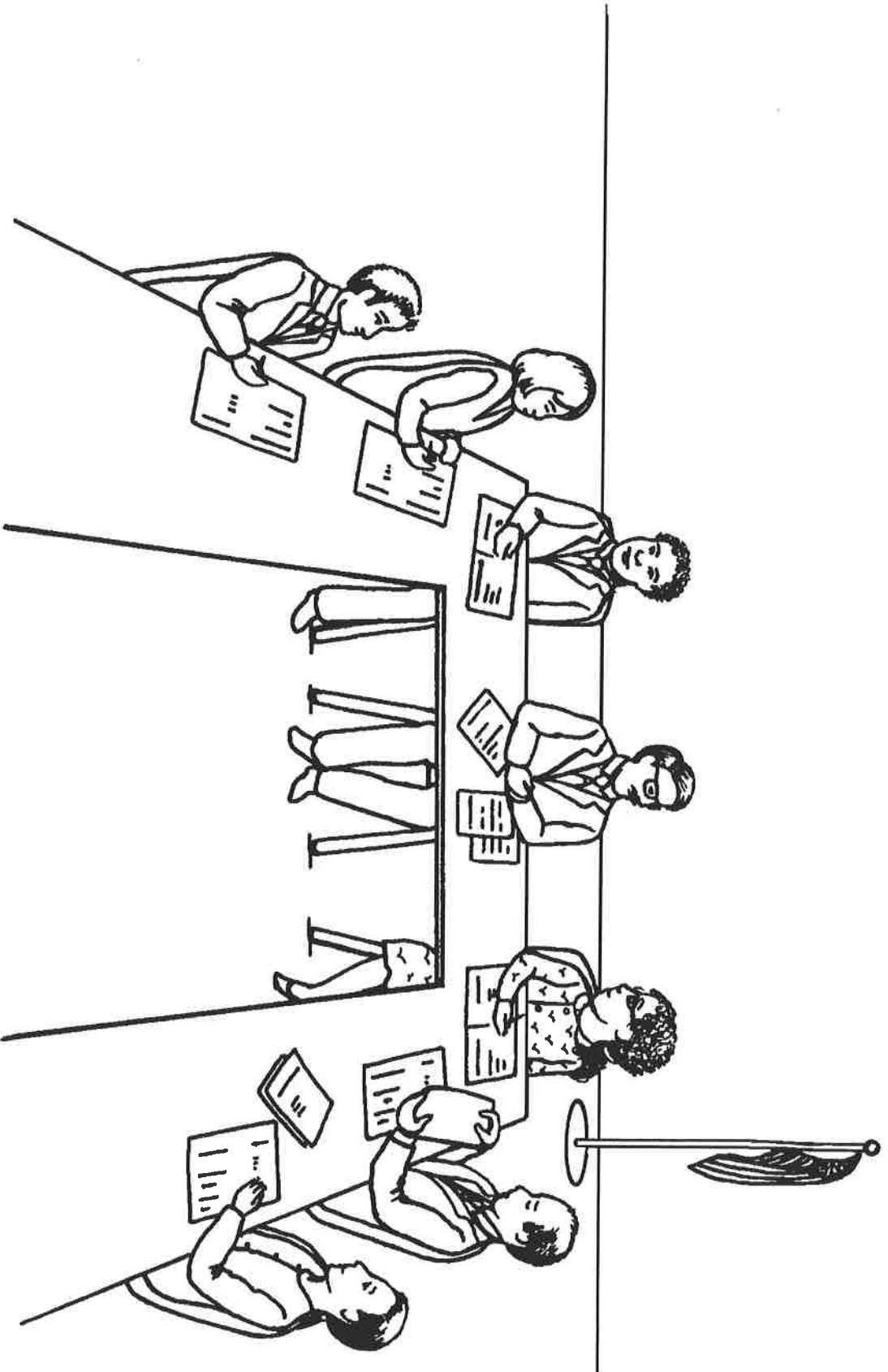

**THE DEMOCRATIC PROCESS:
PARTICIPATING IN STATE AND LOCAL GOVERNMENT**

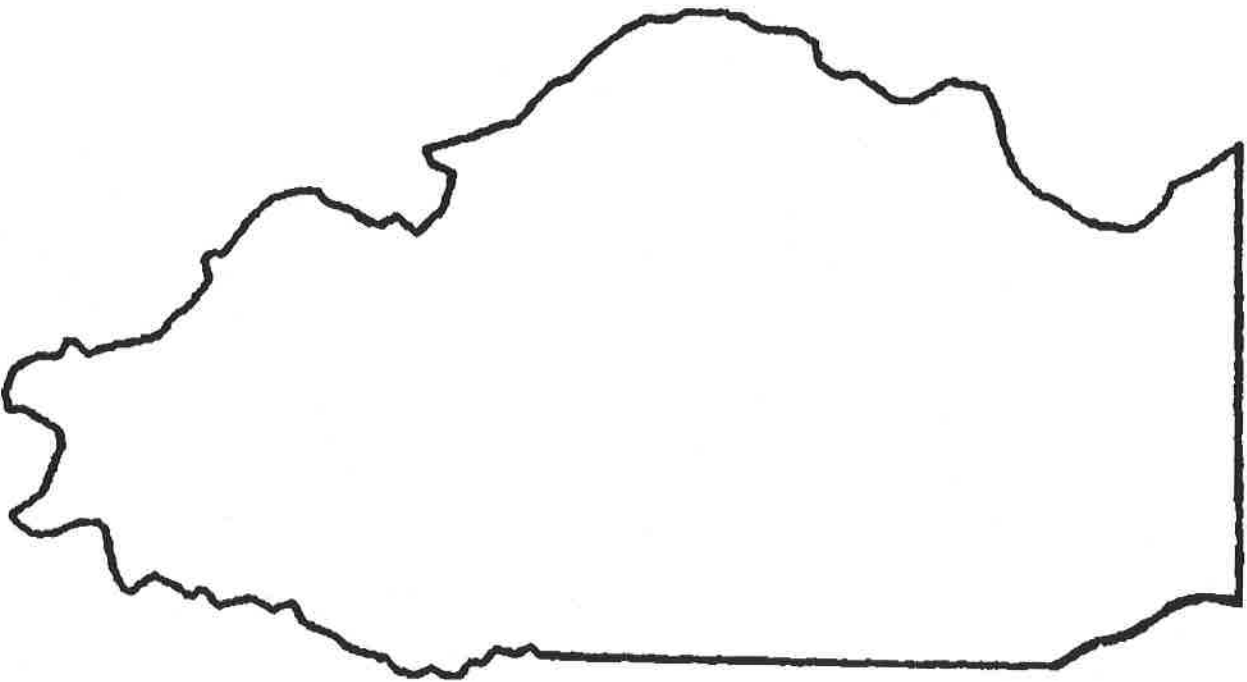

**THE DEMOCRATIC PROCESS:
PARTICIPATING IN STATE AND LOCAL GOVERNMENT**

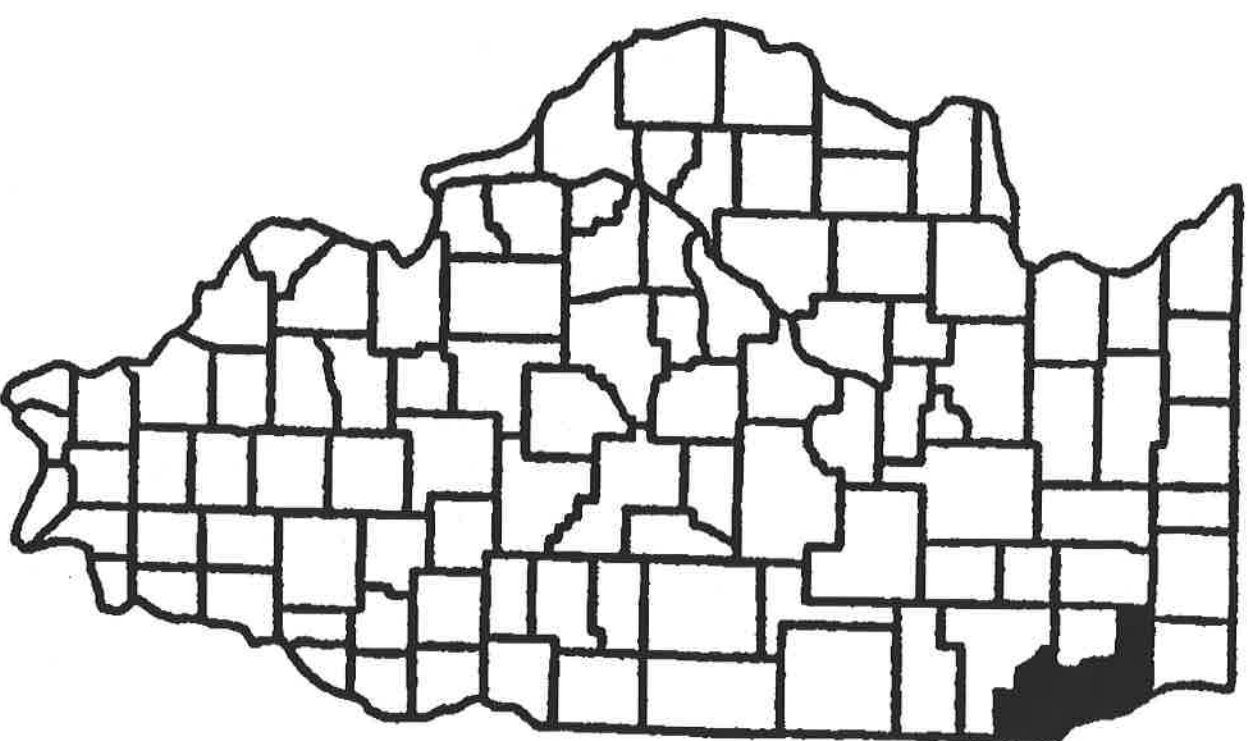

**THE DEMOCRATIC PROCESS:
PARTICIPATING IN STATE AND LOCAL GOVERNMENT**

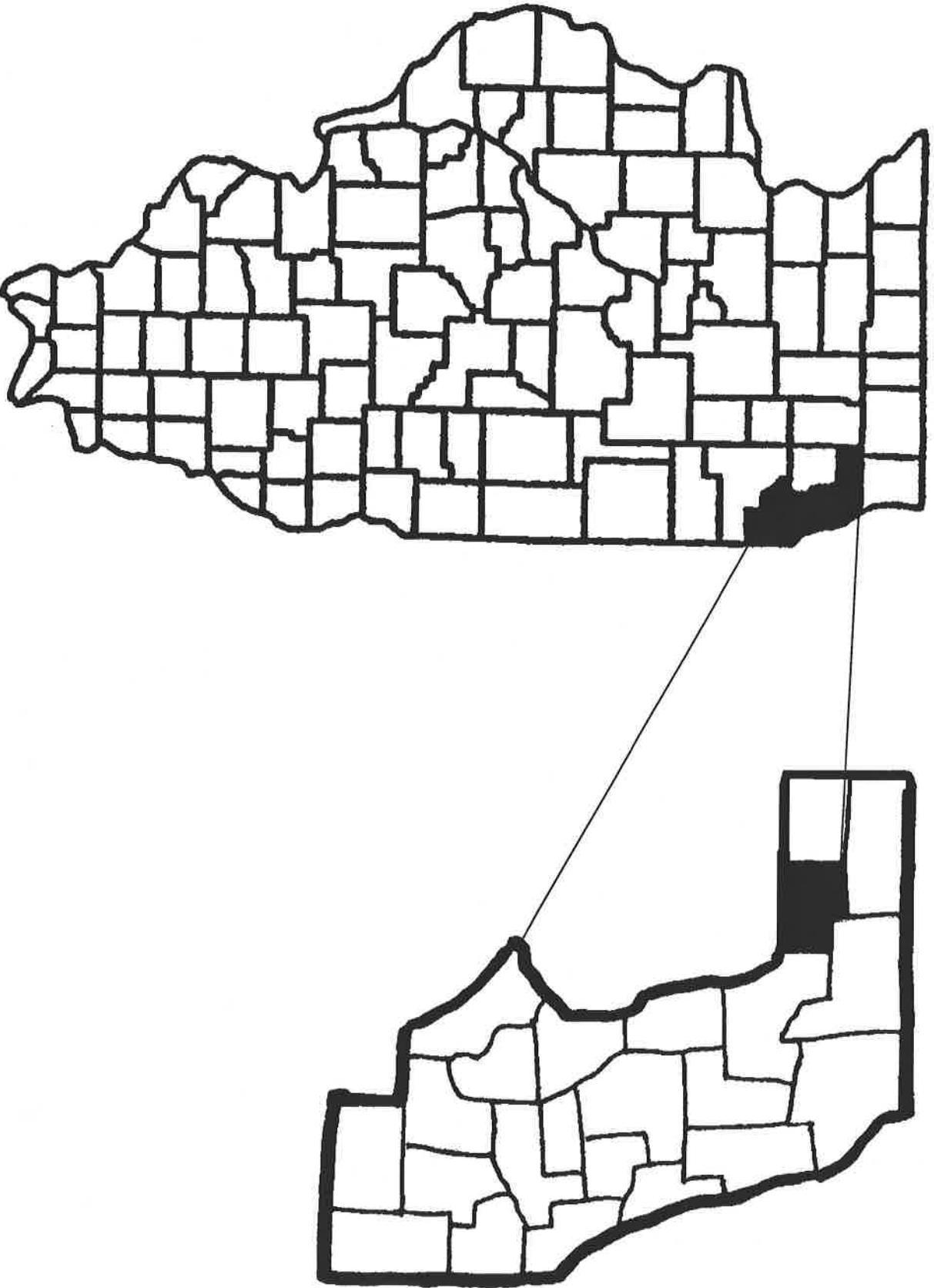

THE DEMOCRATIC PROCESS:
PARTICIPATING IN STATE AND LOCAL GOVERNMENT

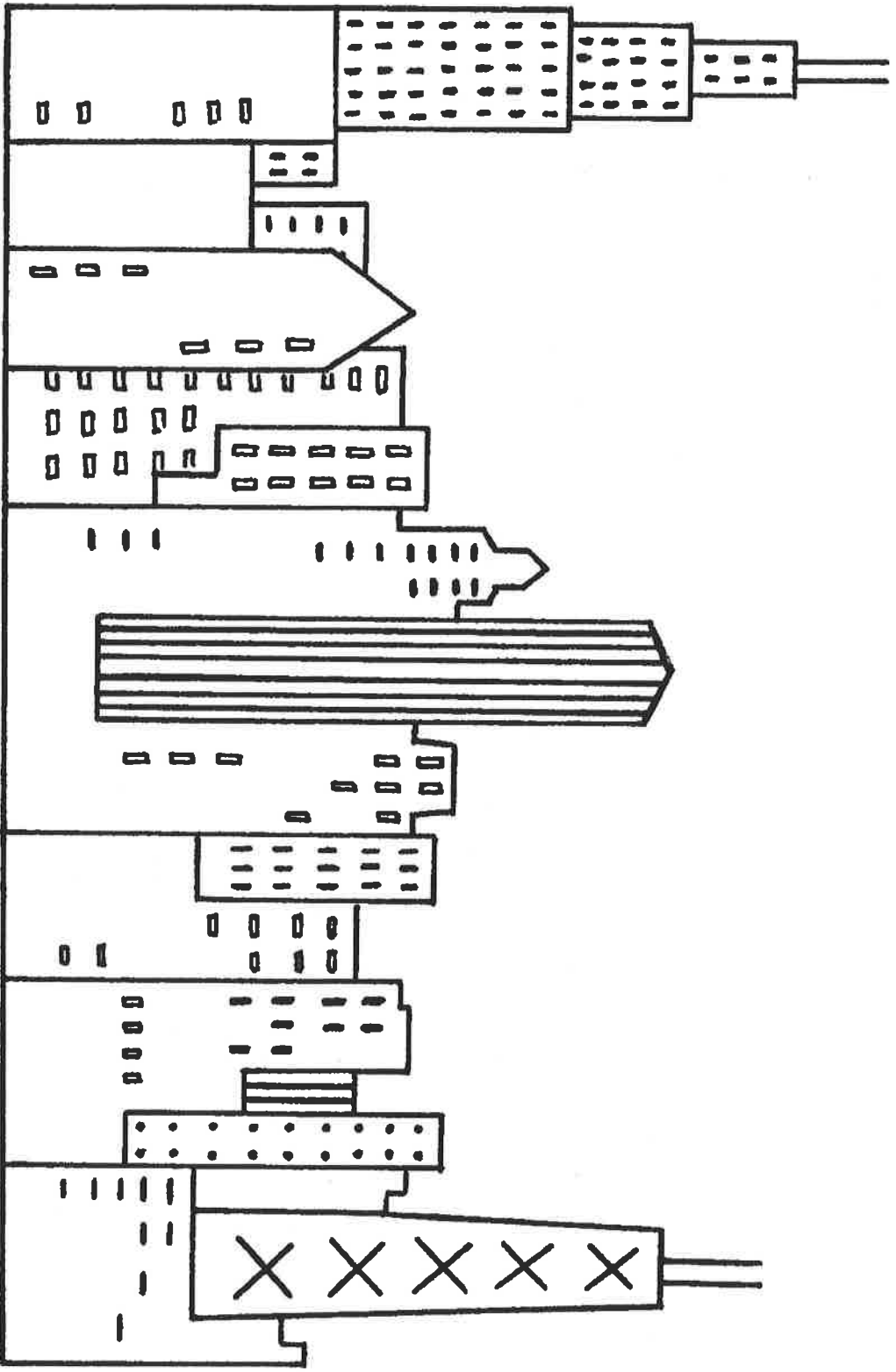

**THE DEMOCRATIC PROCESS:
PARTICIPATING IN STATE AND LOCAL GOVERNMENT**

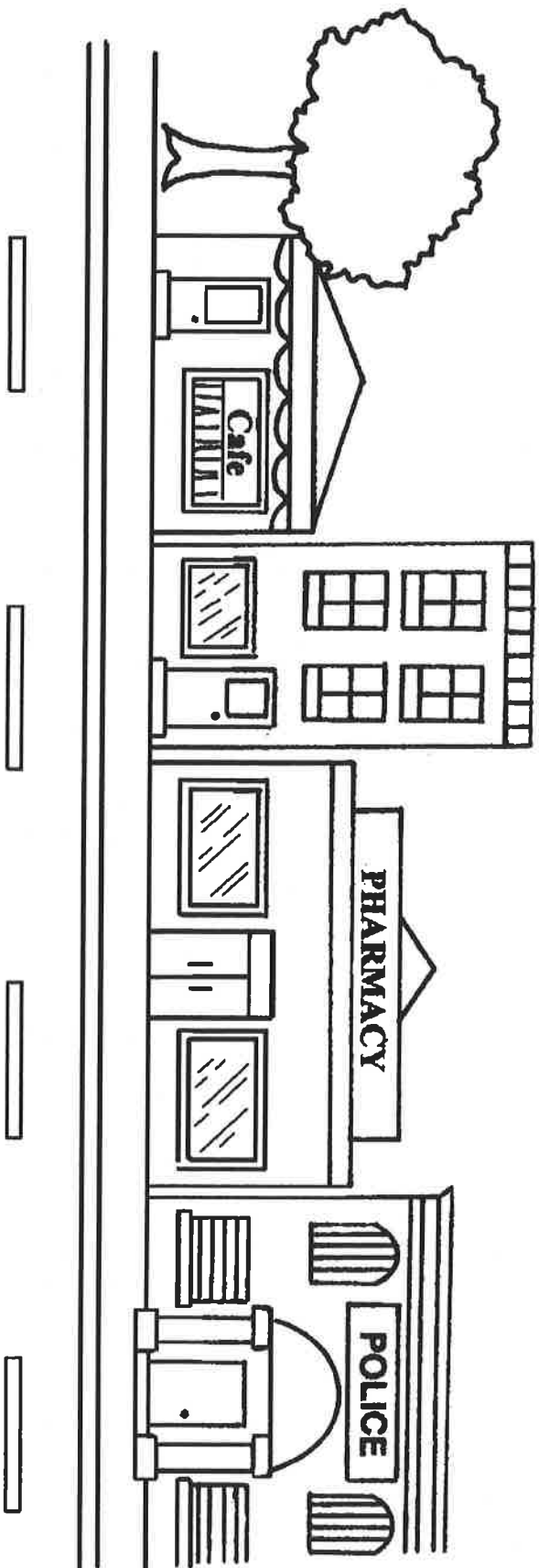

THE DEMOCRATIC PROCESS:
PARTICIPATING IN STATE AND LOCAL GOVERNMENT

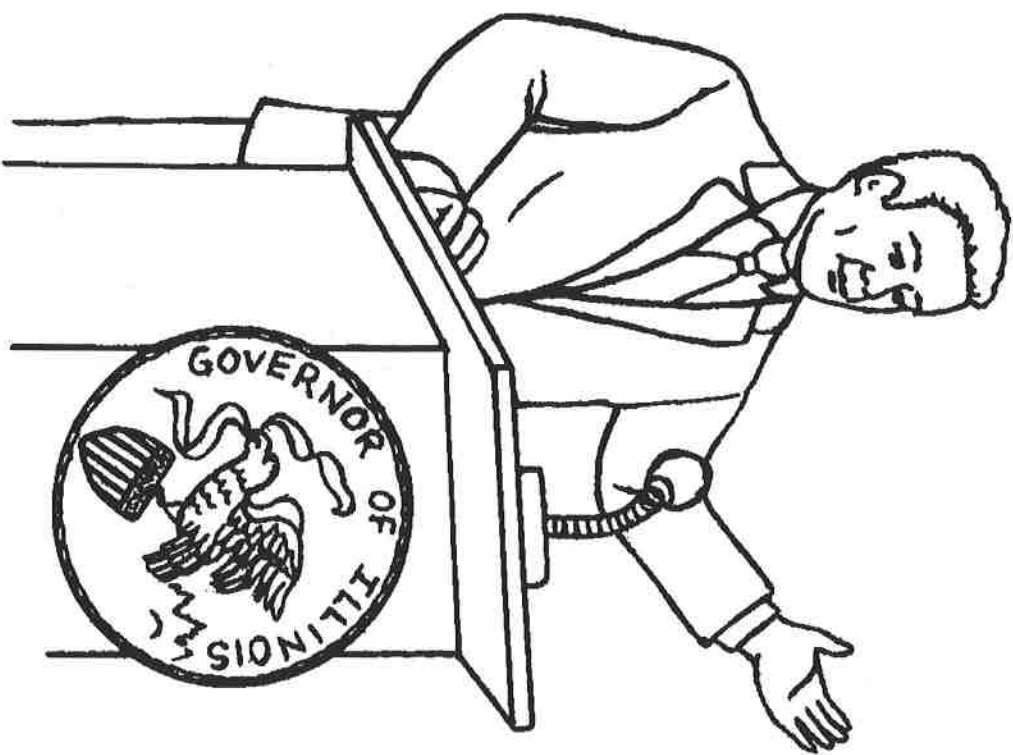
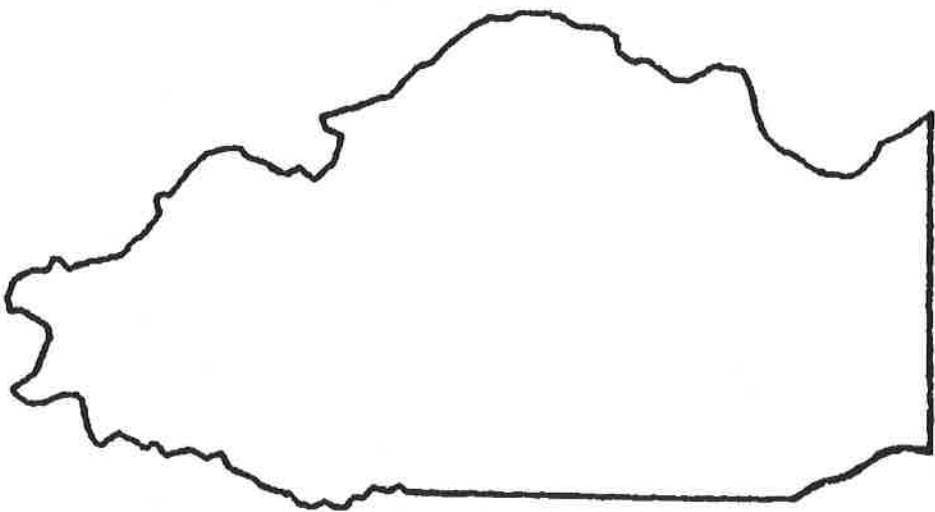

**THE DEMOCRATIC PROCESS:
PARTICIPATING IN STATE AND LOCAL GOVERNMENT**

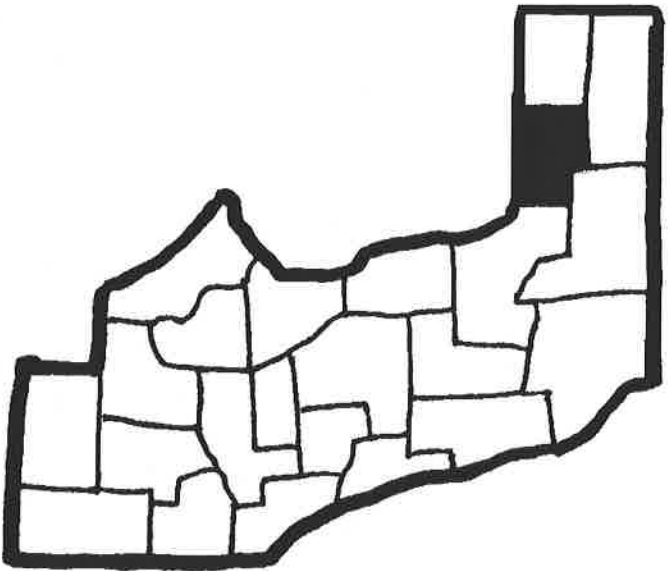

**THE DEMOCRATIC PROCESS:
PARTICIPATING IN STATE AND LOCAL GOVERNMENT**

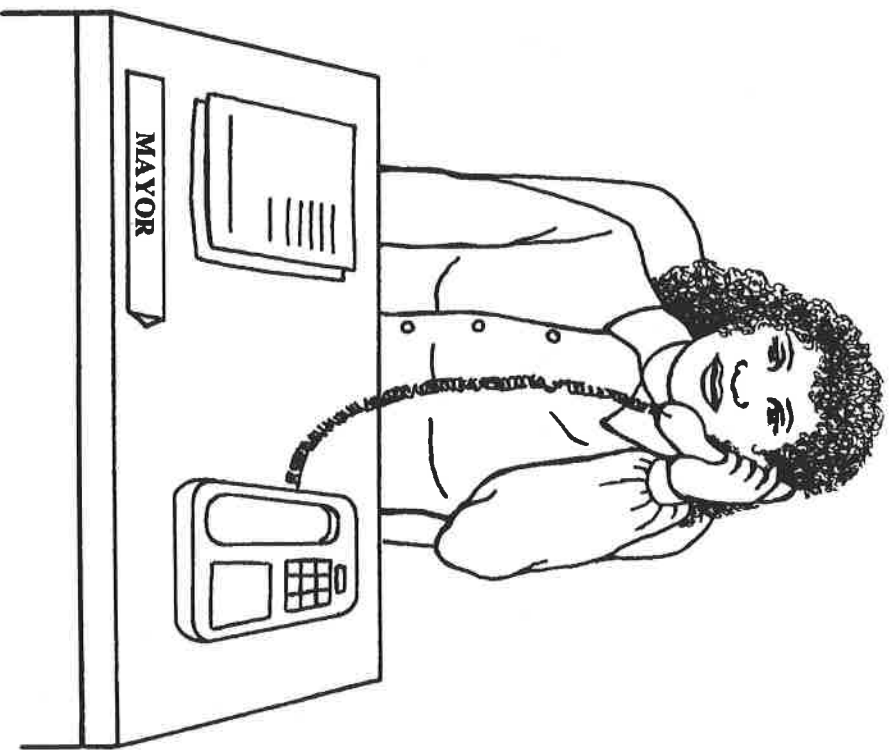
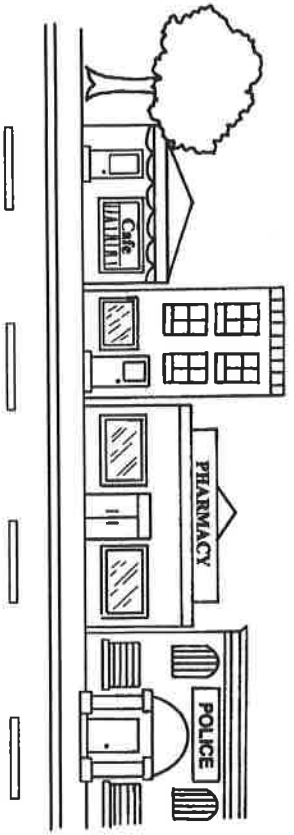
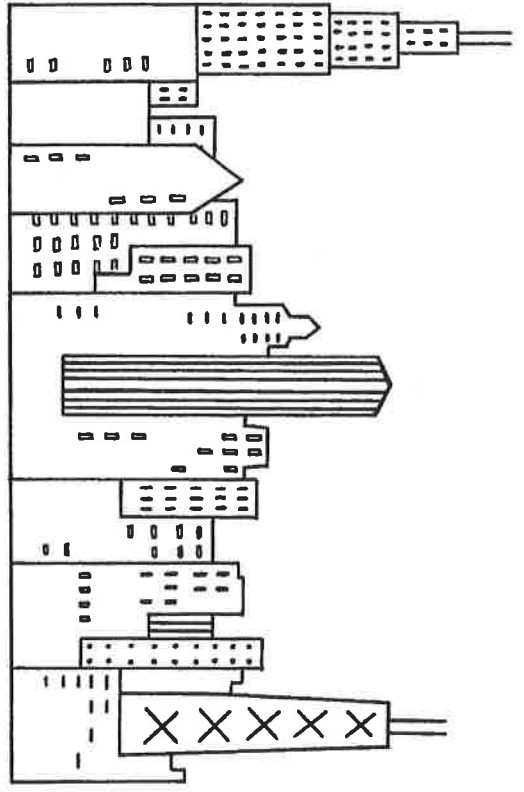

**THE DEMOCRATIC PROCESS:
PARTICIPATING IN STATE AND LOCAL GOVERNMENT**

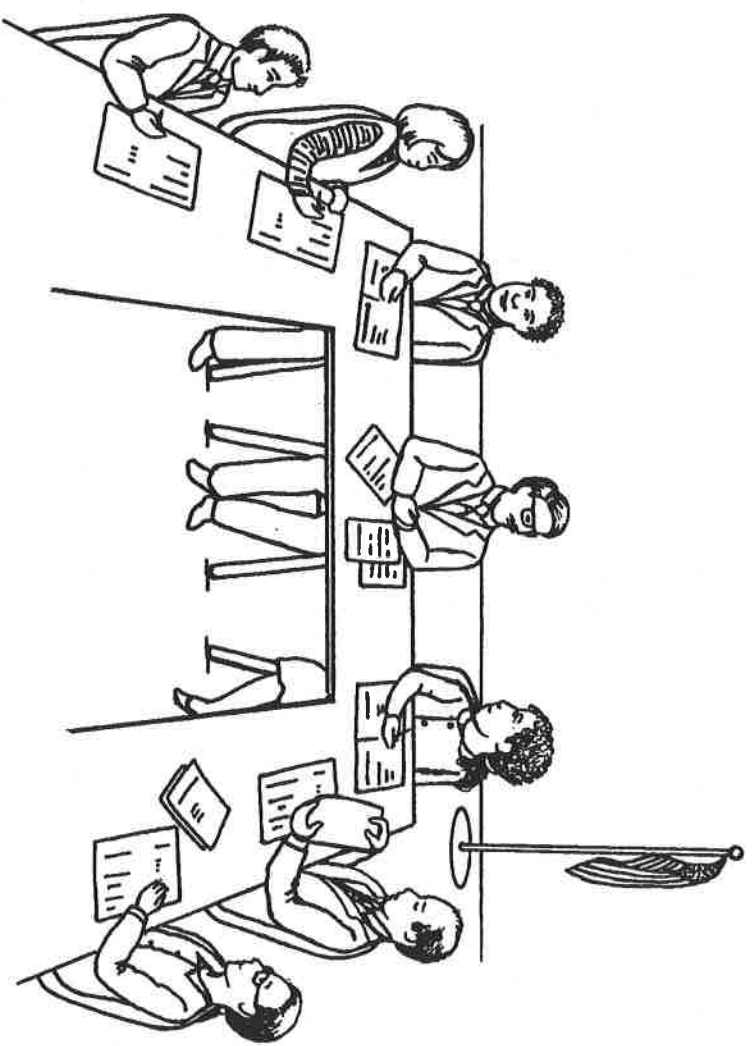
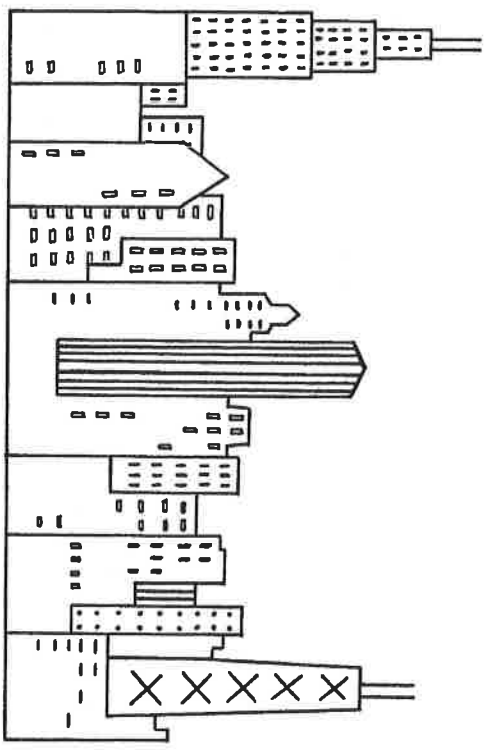

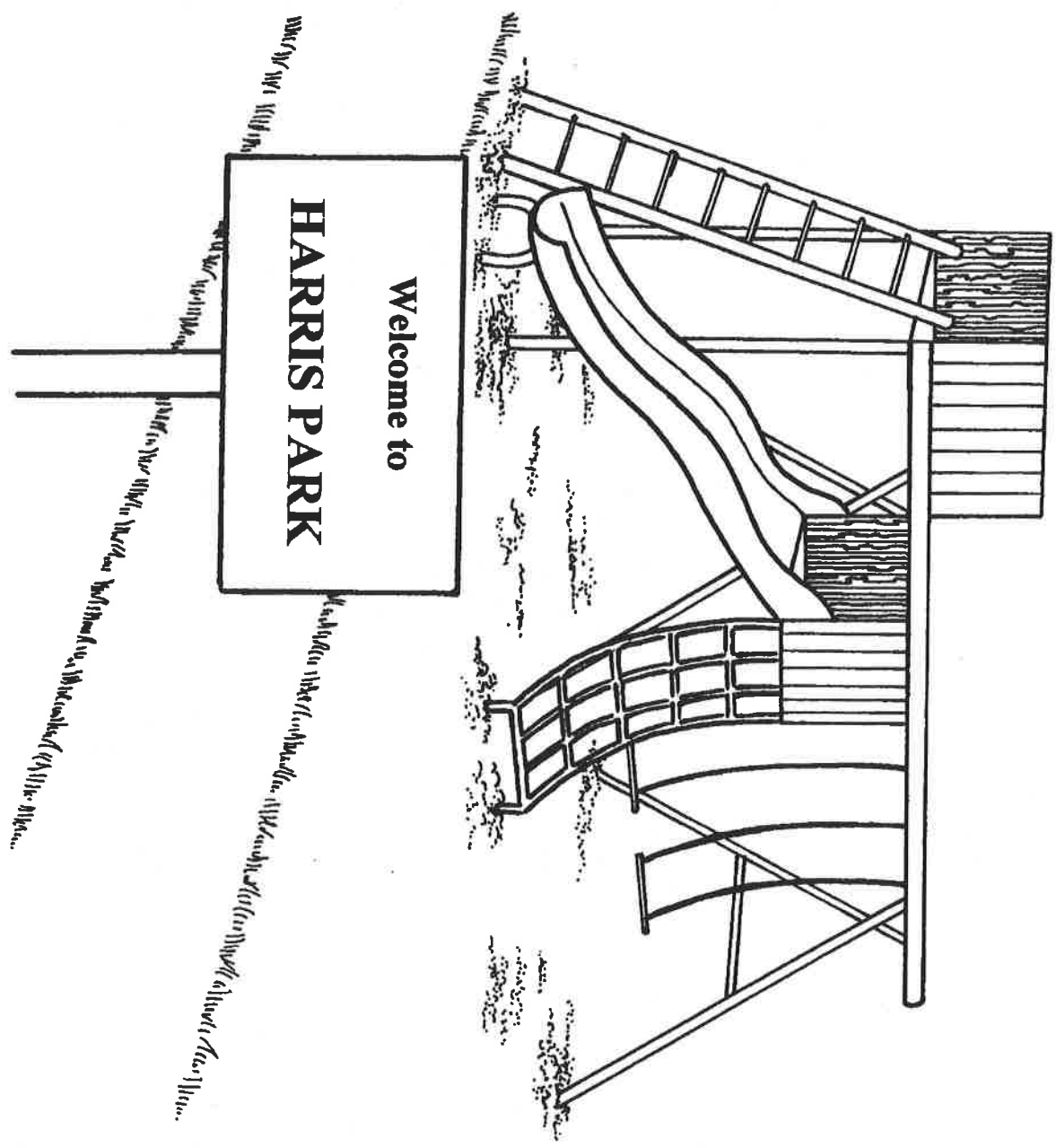

THE DEMOCRATIC PROCESS:
PARTICIPATING IN STATE AND LOCAL GOVERNMENT



**THE DEMOCRATIC PROCESS:
PARTICIPATING IN STATE AND LOCAL GOVERNMENT**

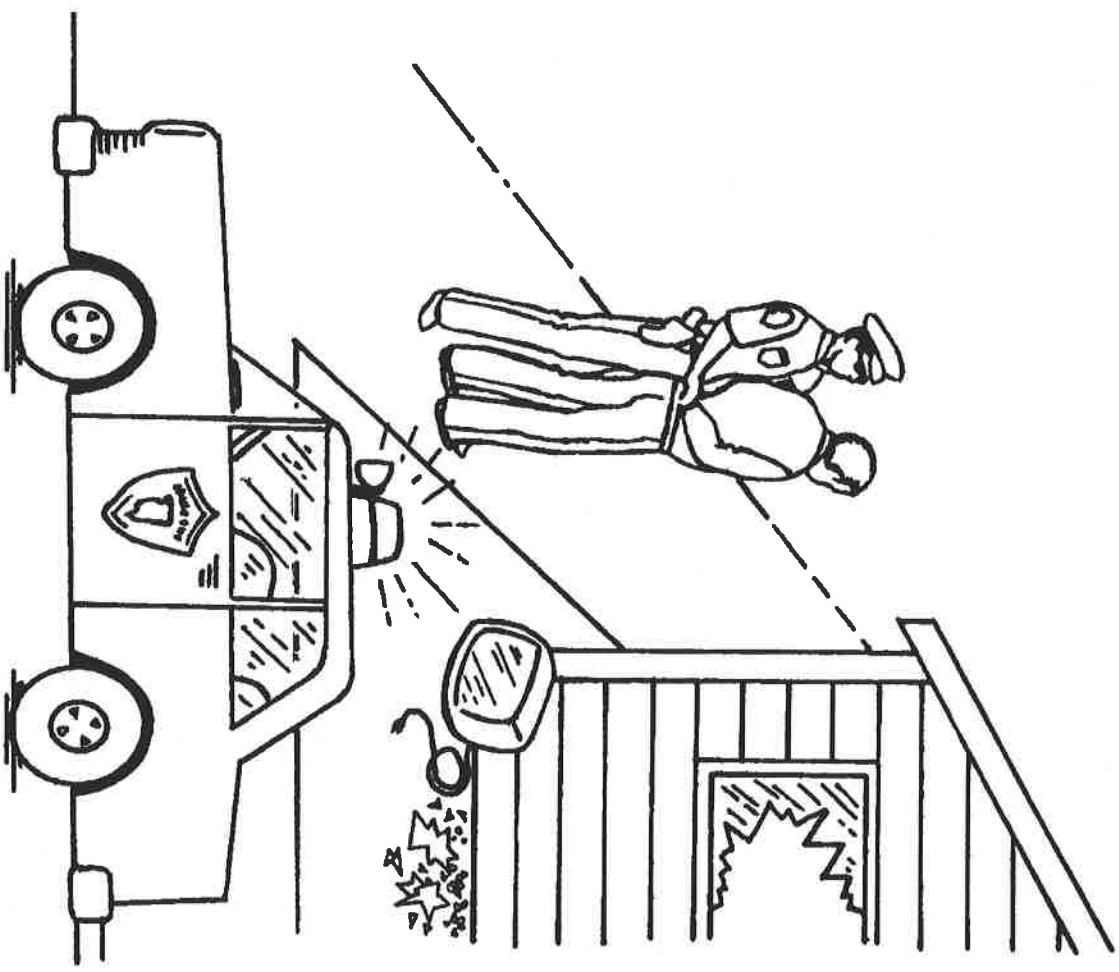

THE DEMOCRATIC PROCESS:
PARTICIPATING IN STATE AND LOCAL GOVERNMENT

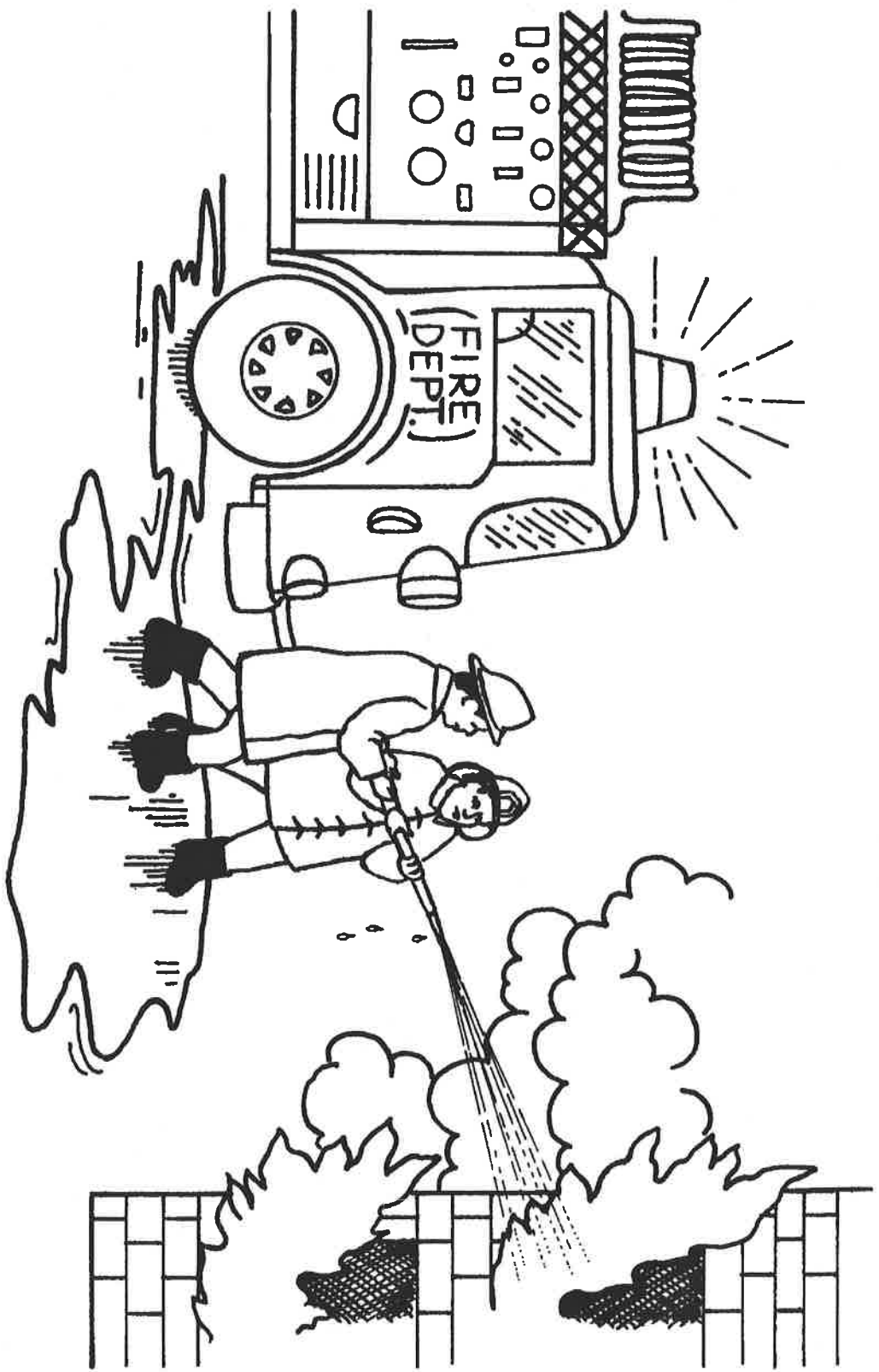

**THE DEMOCRATIC PROCESS:
PARTICIPATING IN STATE AND LOCAL GOVERNMENT**

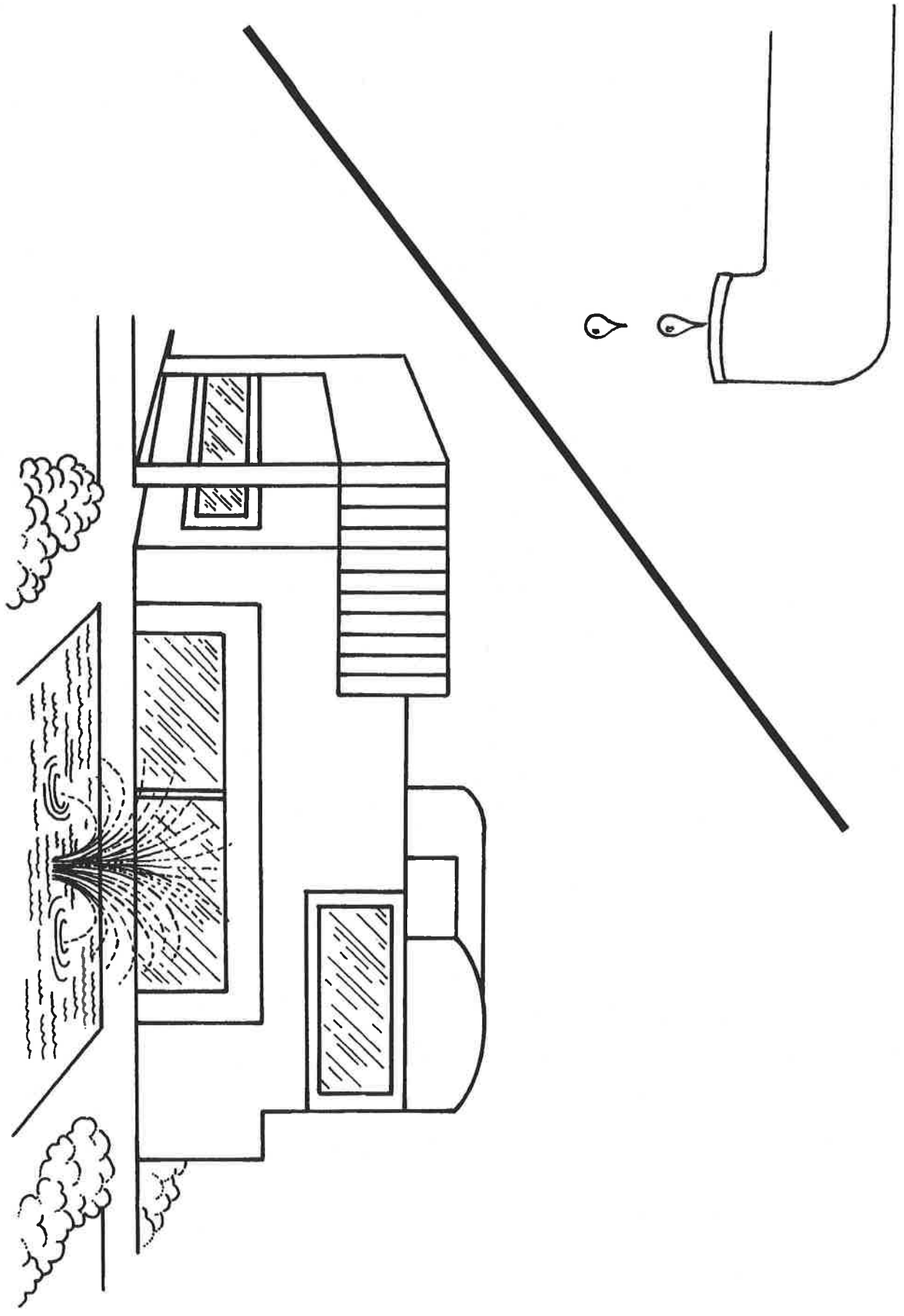

**THE DEMOCRATIC PROCESS:
PARTICIPATING IN STATE AND LOCAL GOVERNMENT**

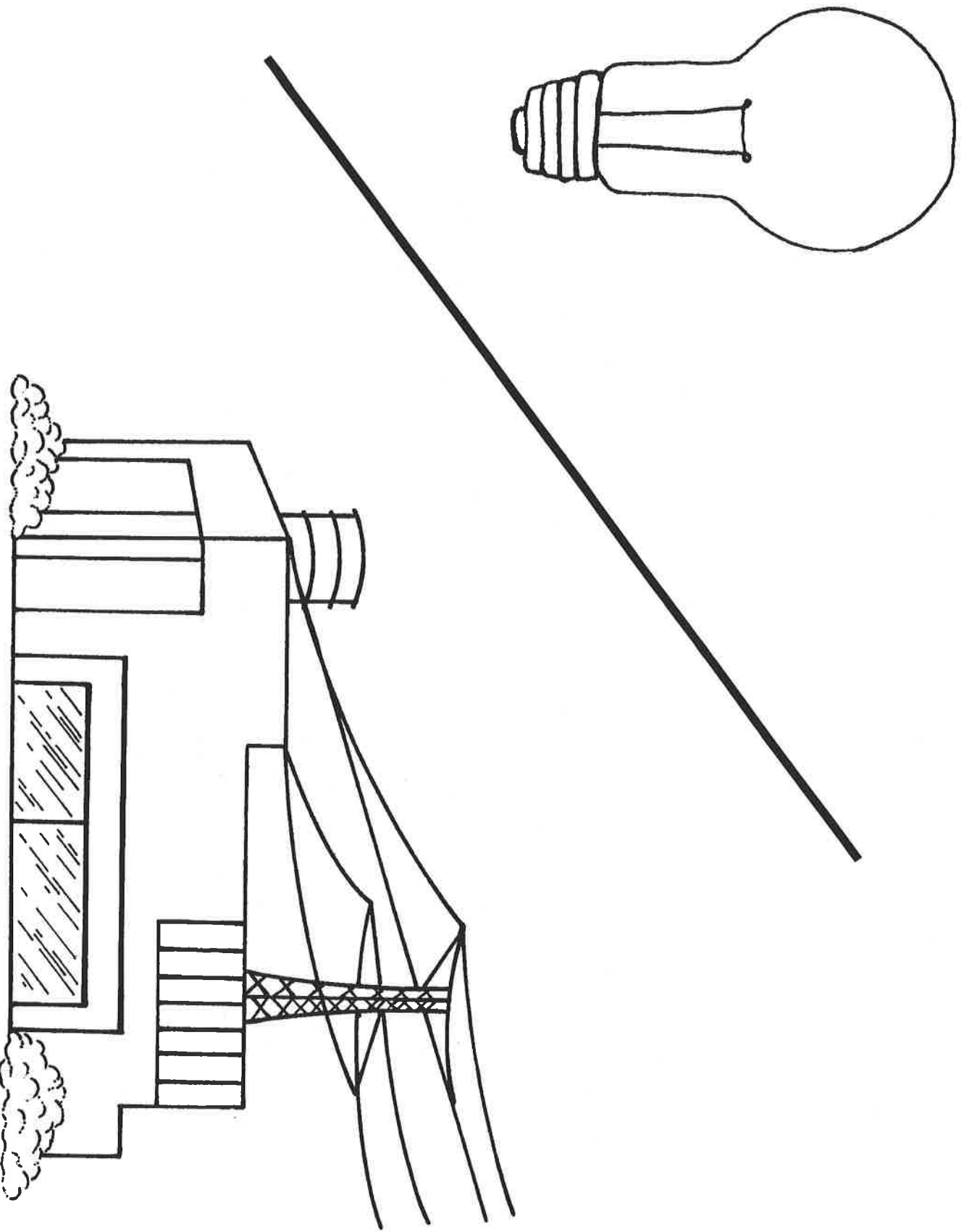

**THE DEMOCRATIC PROCESS:
PARTICIPATING IN STATE AND LOCAL GOVERNMENT**

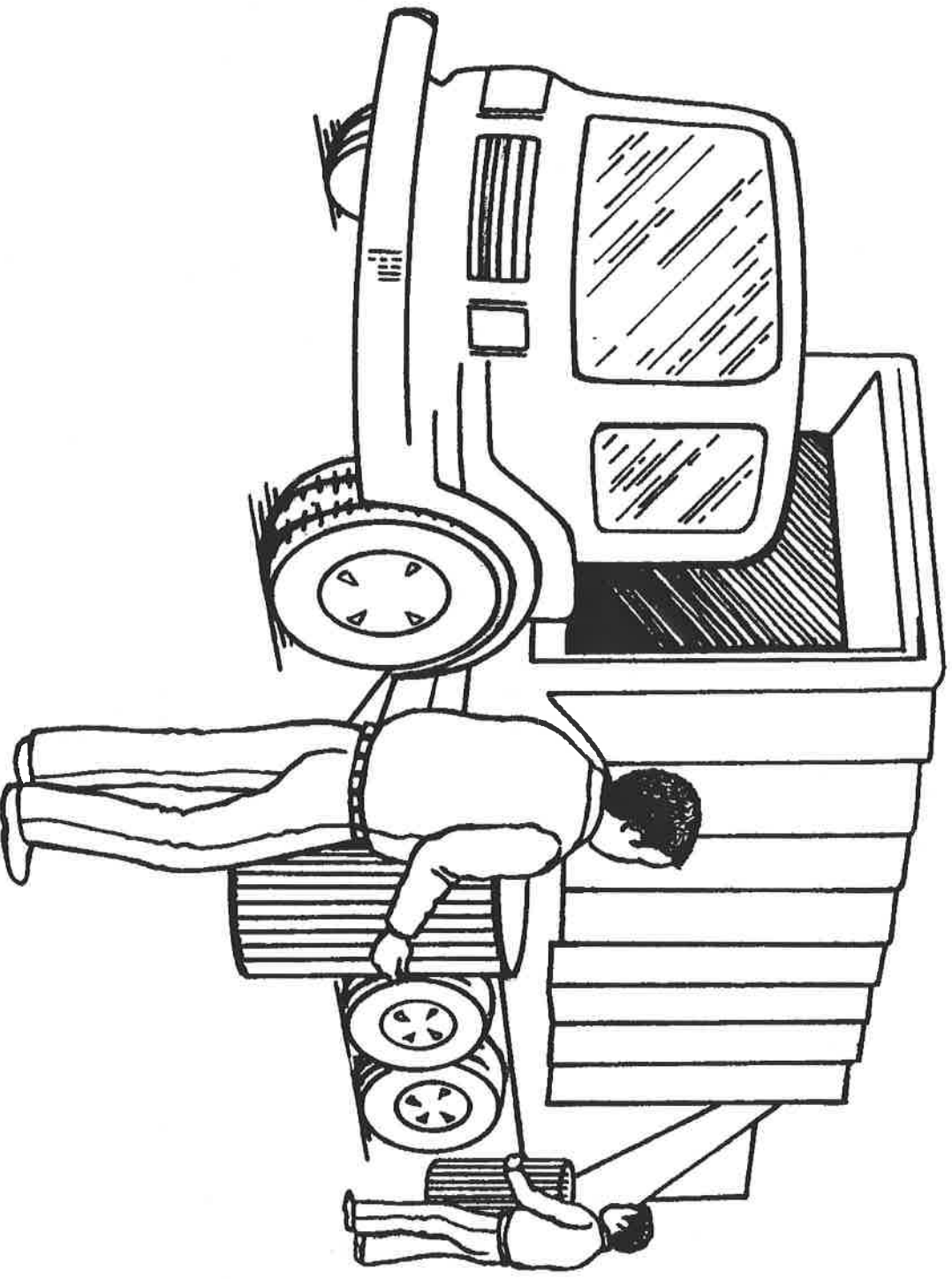

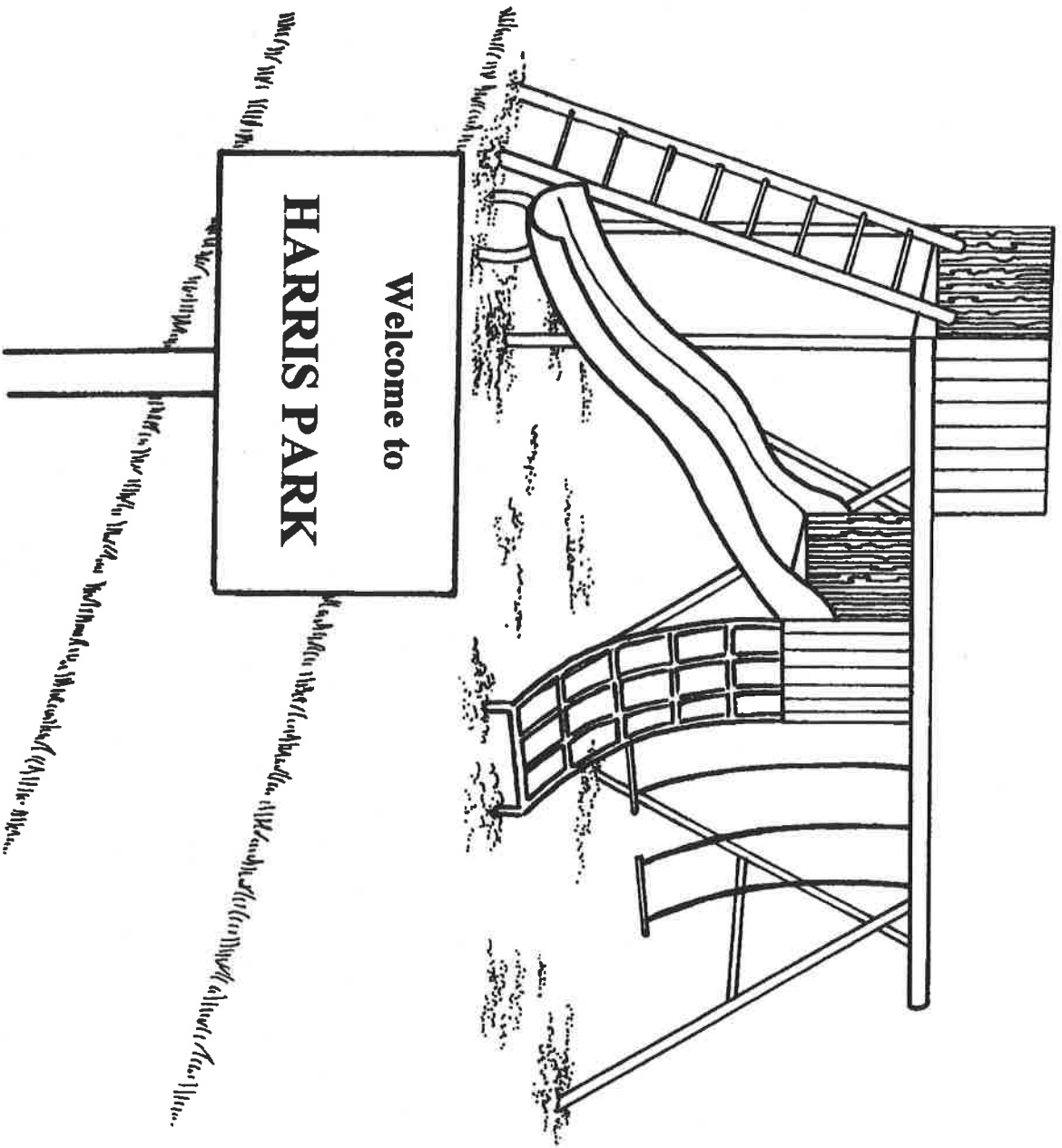

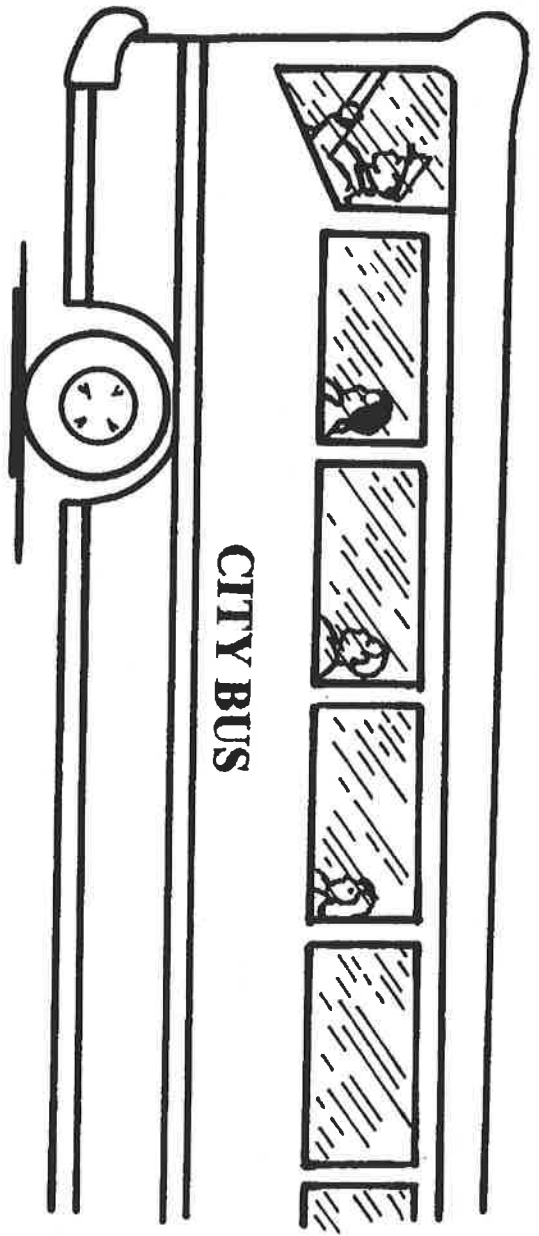
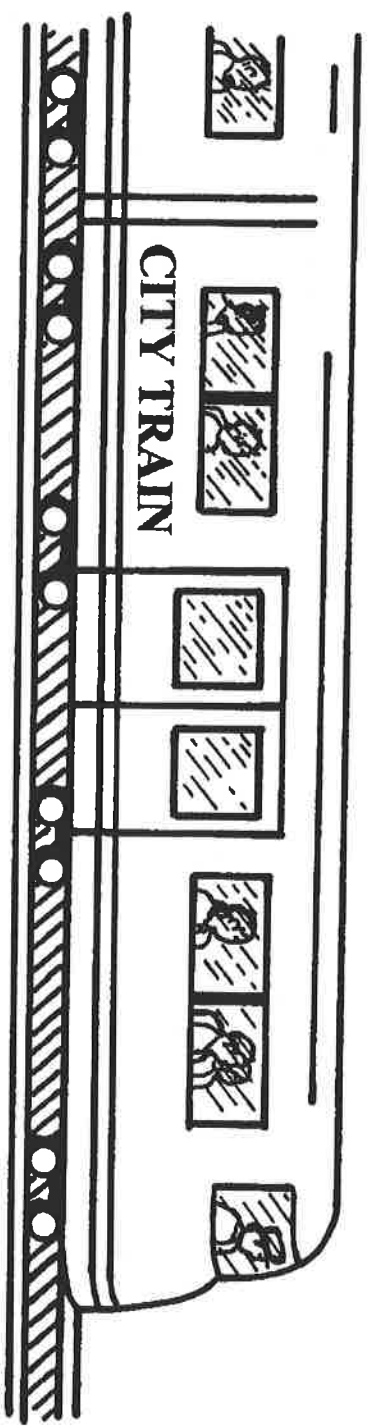

**THE DEMOCRATIC PROCESS:
PARTICIPATING IN STATE AND LOCAL GOVERNMENT**

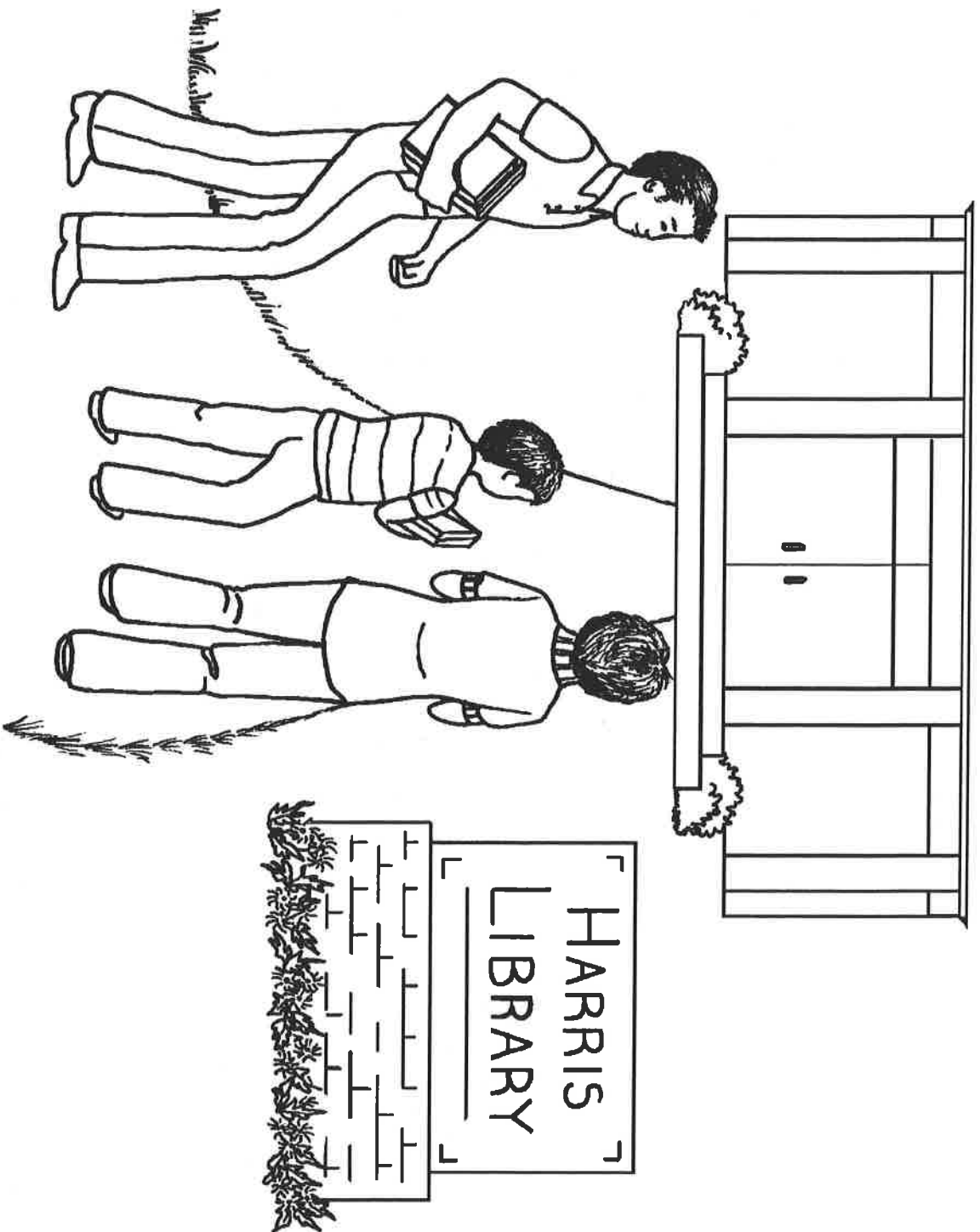

THE DEMOCRATIC PROCESS:
PARTICIPATING IN STATE AND LOCAL GOVERNMENT

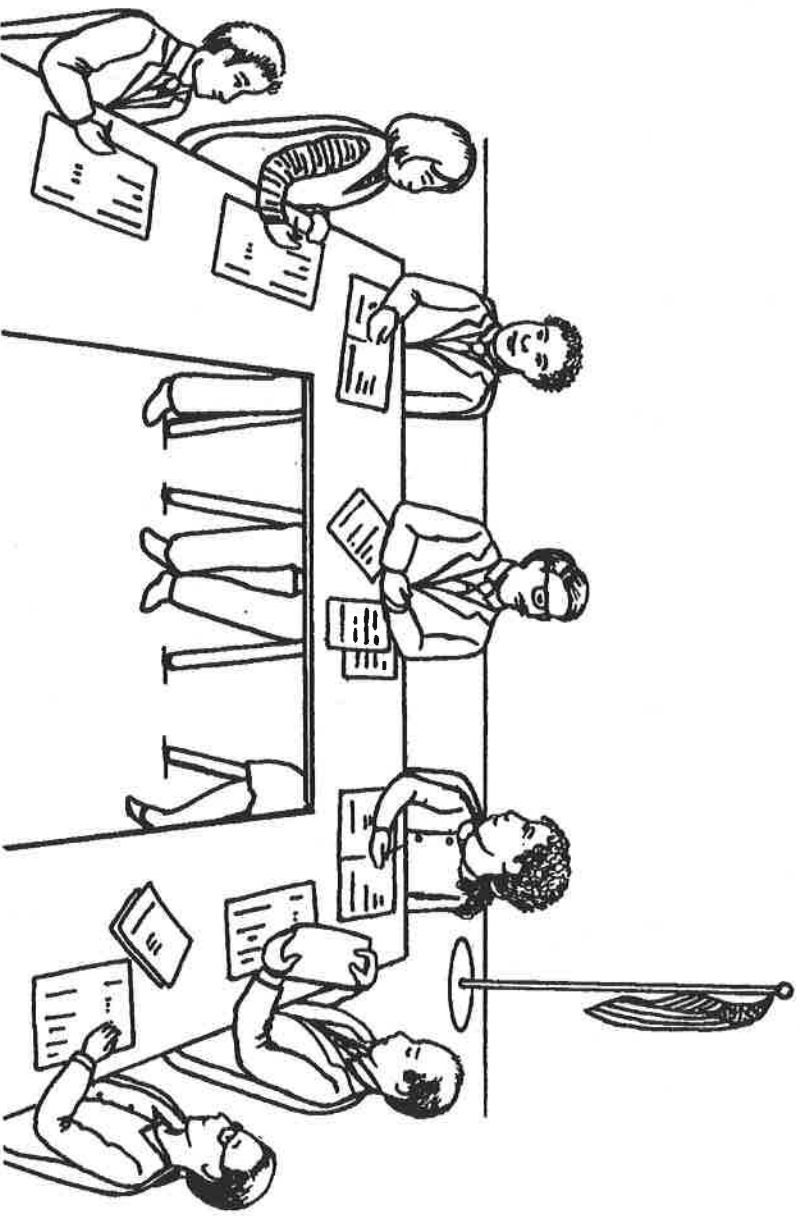
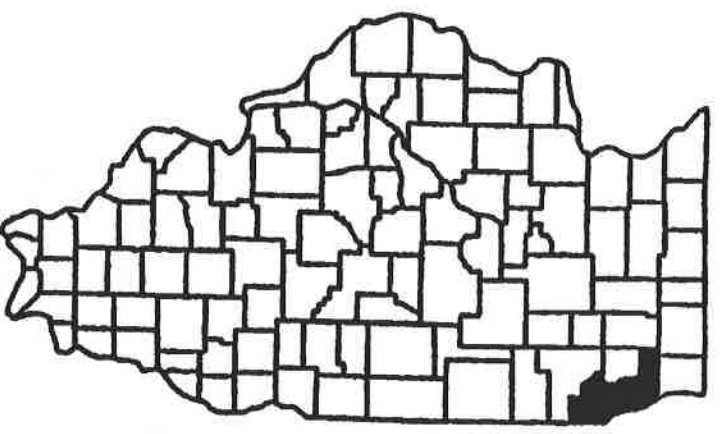

**THE DEMOCRATIC PROCESS:
PARTICIPATING IN STATE AND LOCAL GOVERNMENT**

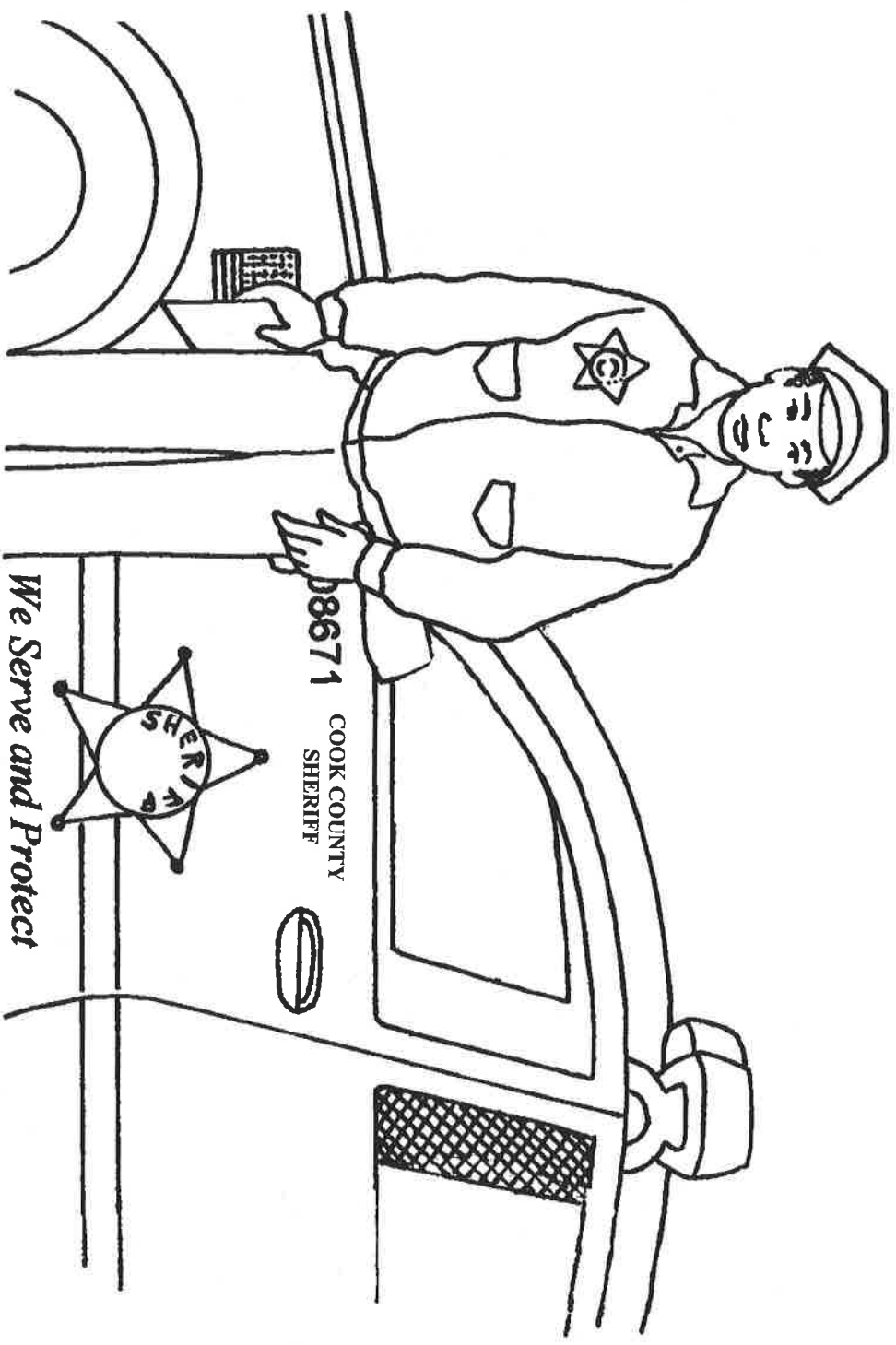

**THE DEMOCRATIC PROCESS:
PARTICIPATING IN STATE AND LOCAL GOVERNMENT**

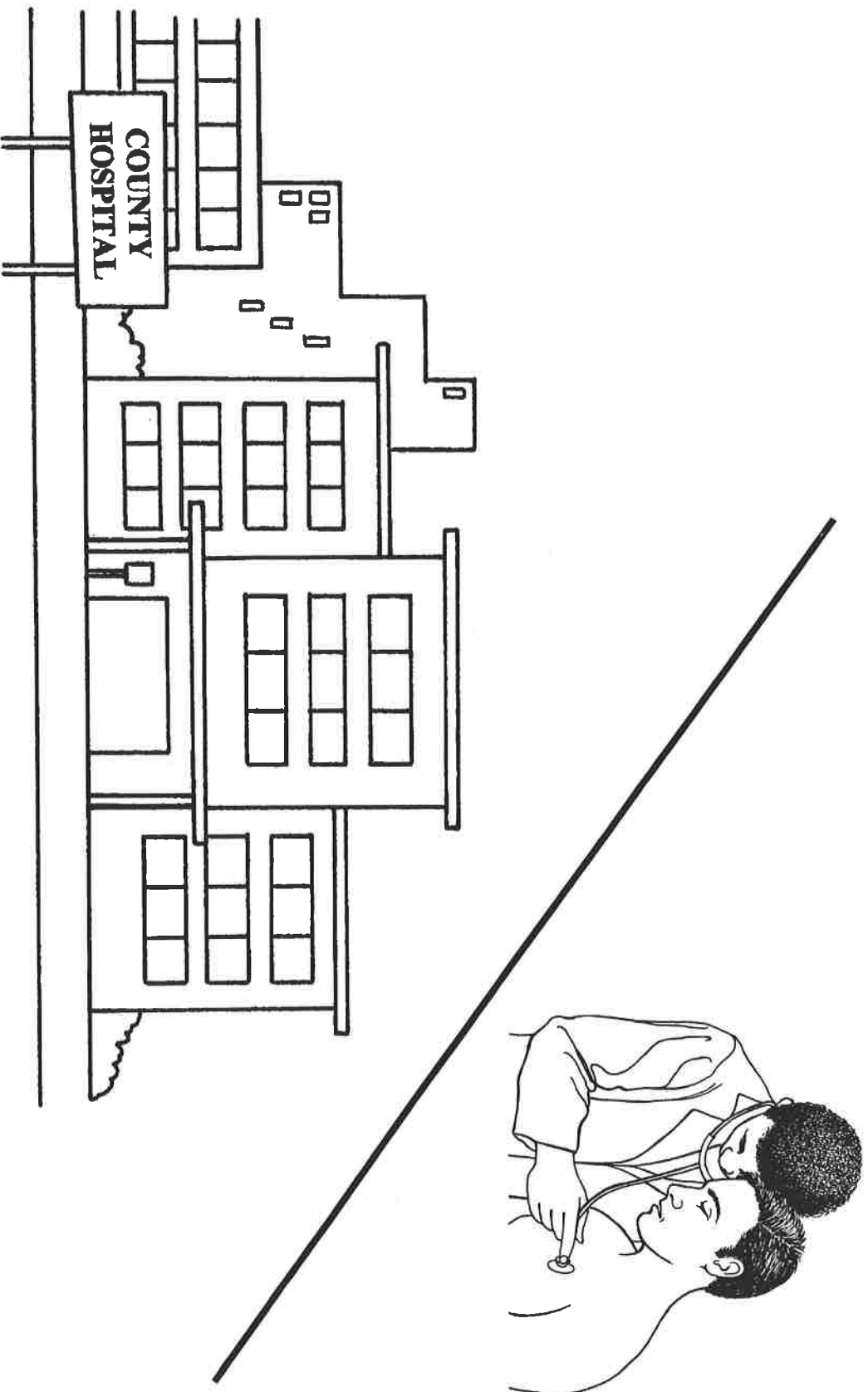

**THE DEMOCRATIC PROCESS:
PARTICIPATING IN STATE AND LOCAL GOVERNMENT**

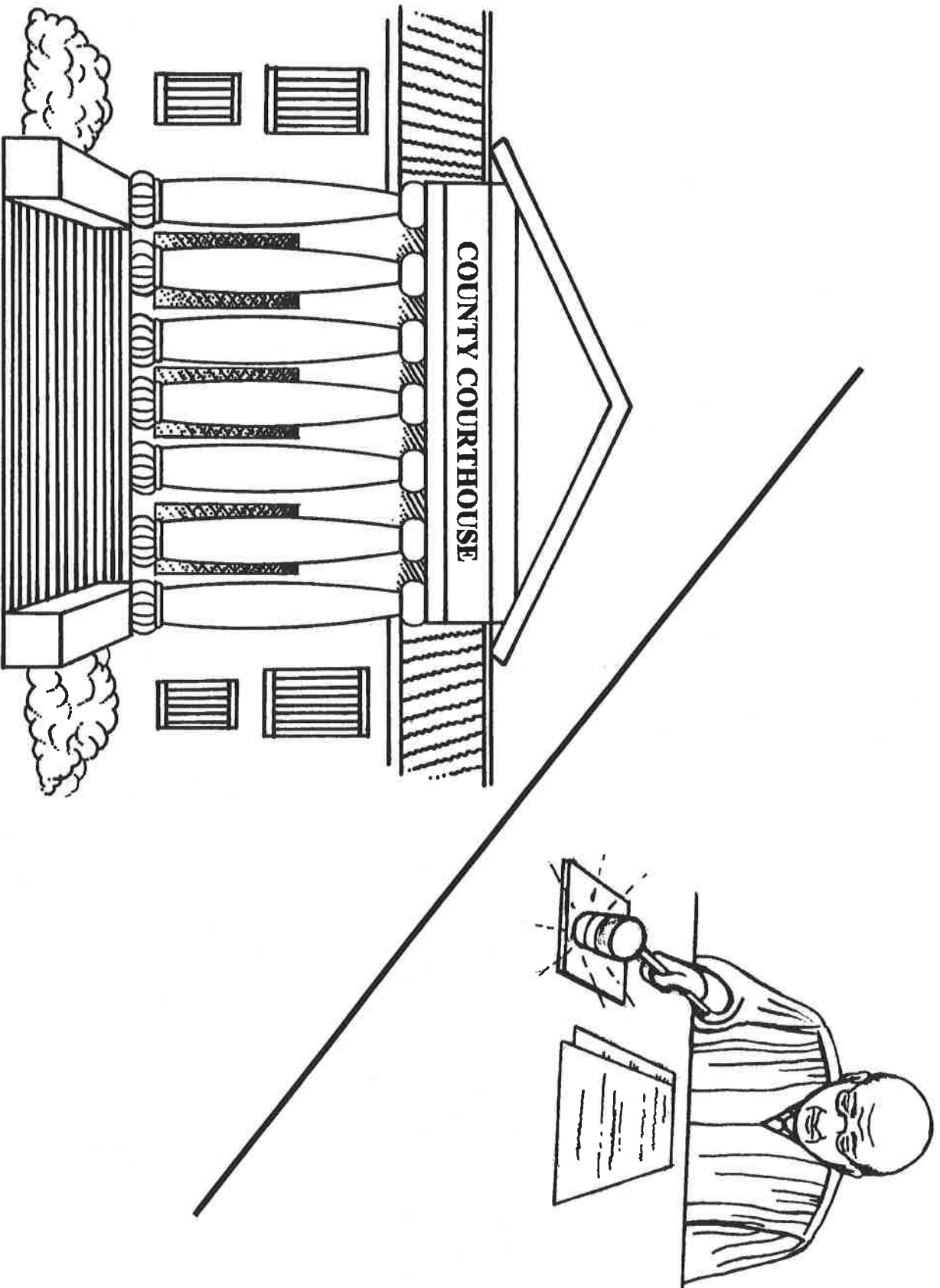

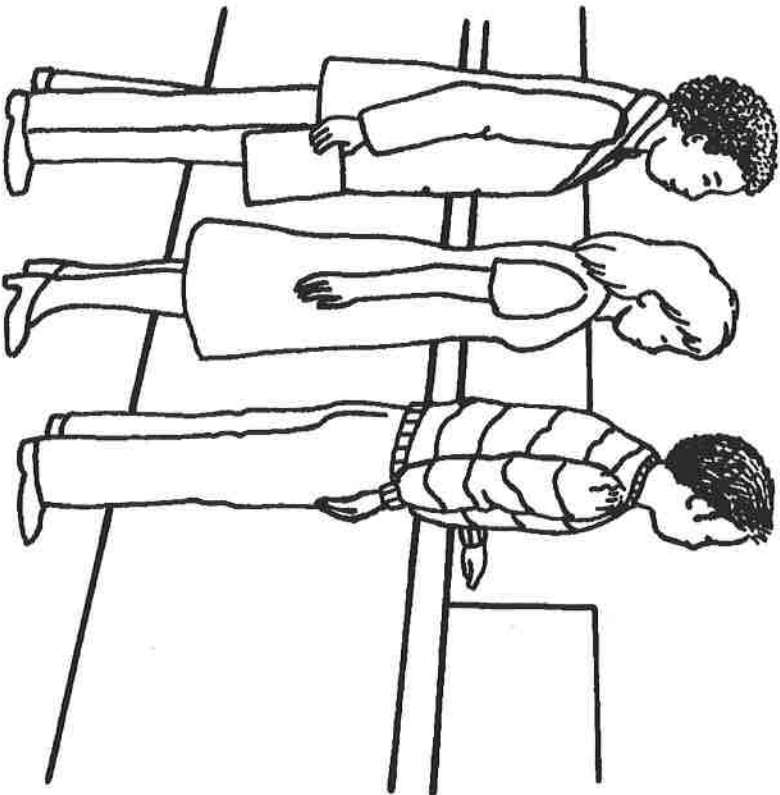
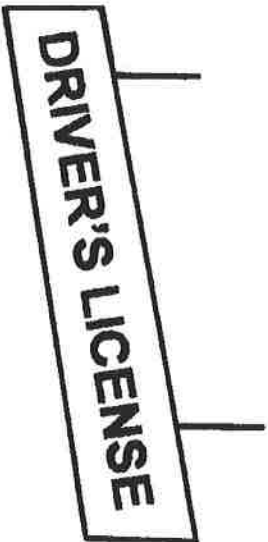

DRIVER'S LICENSE
Number: X243-3654-3059

Mauricio Perez
312 South Manor
Wood Dale, IL 60037
SS# _____

Mauricio Perez



**THE DEMOCRATIC PROCESS:
PARTICIPATING IN STATE AND LOCAL GOVERNMENT**

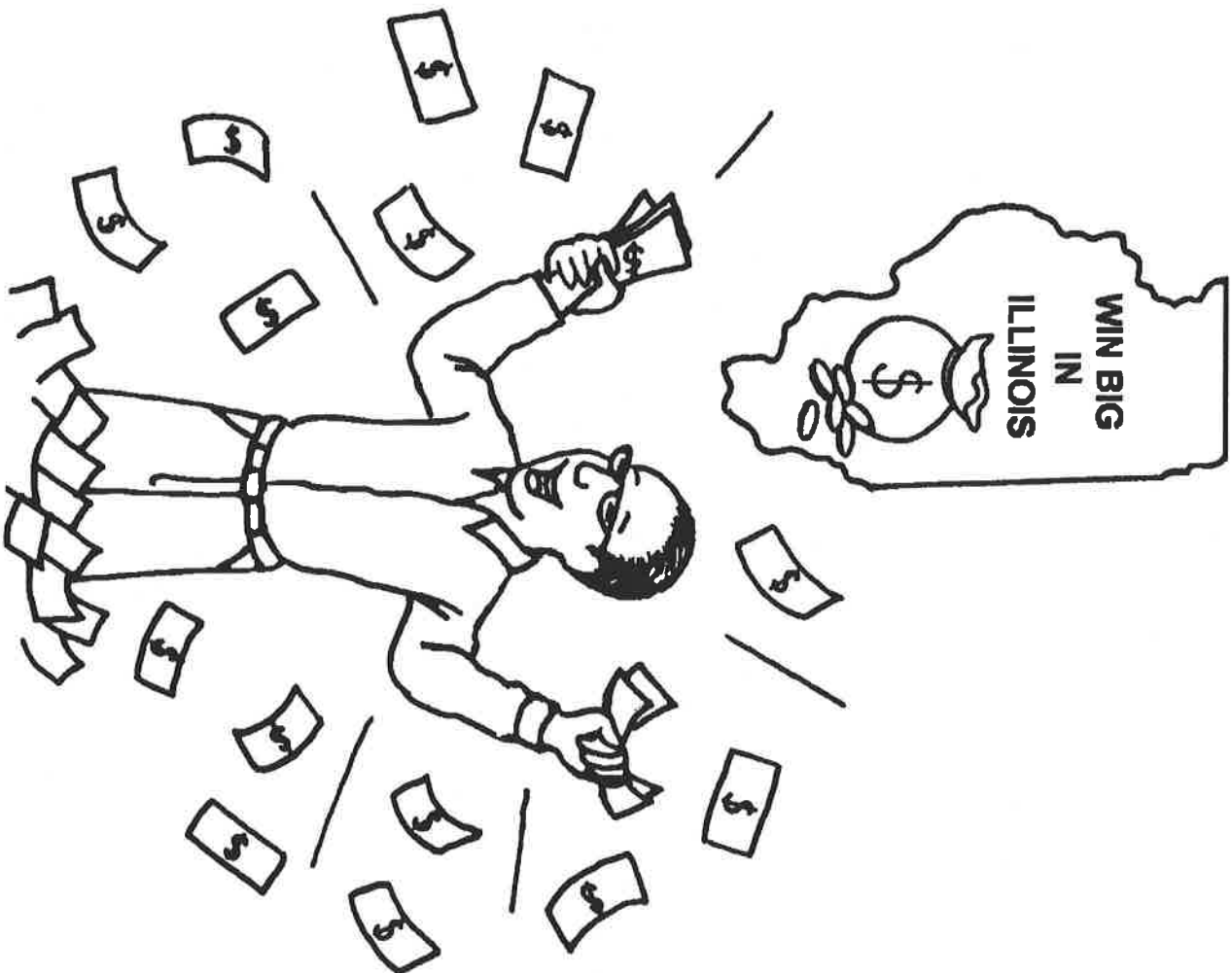

**THE DEMOCRATIC PROCESS:
PARTICIPATING IN STATE AND LOCAL GOVERNMENT**

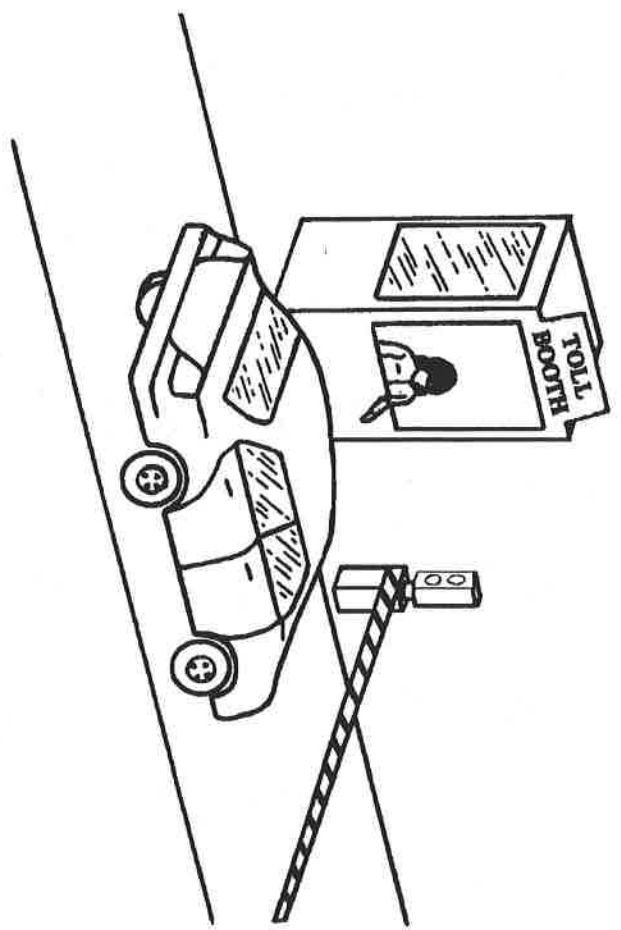
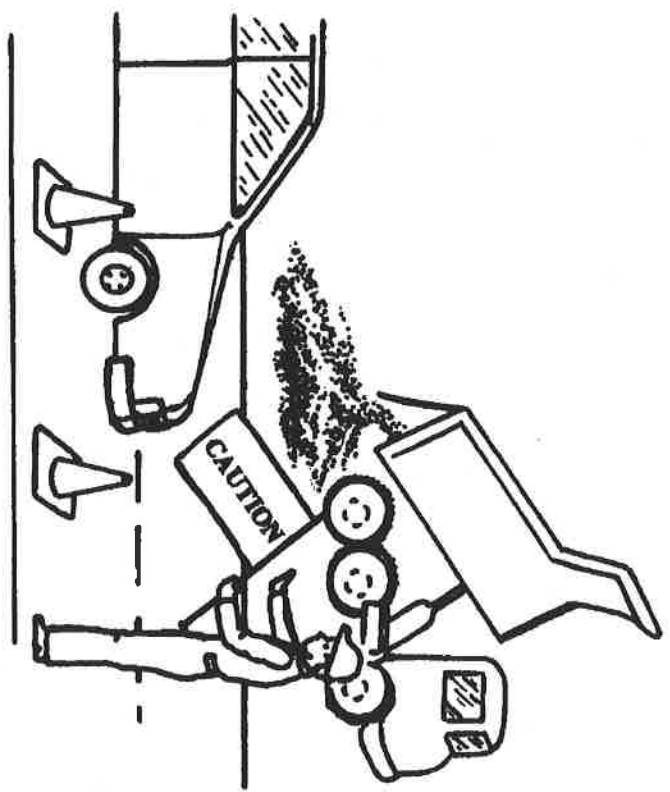

**THE DEMOCRATIC PROCESS:
PARTICIPATING IN STATE AND LOCAL GOVERNMENT**

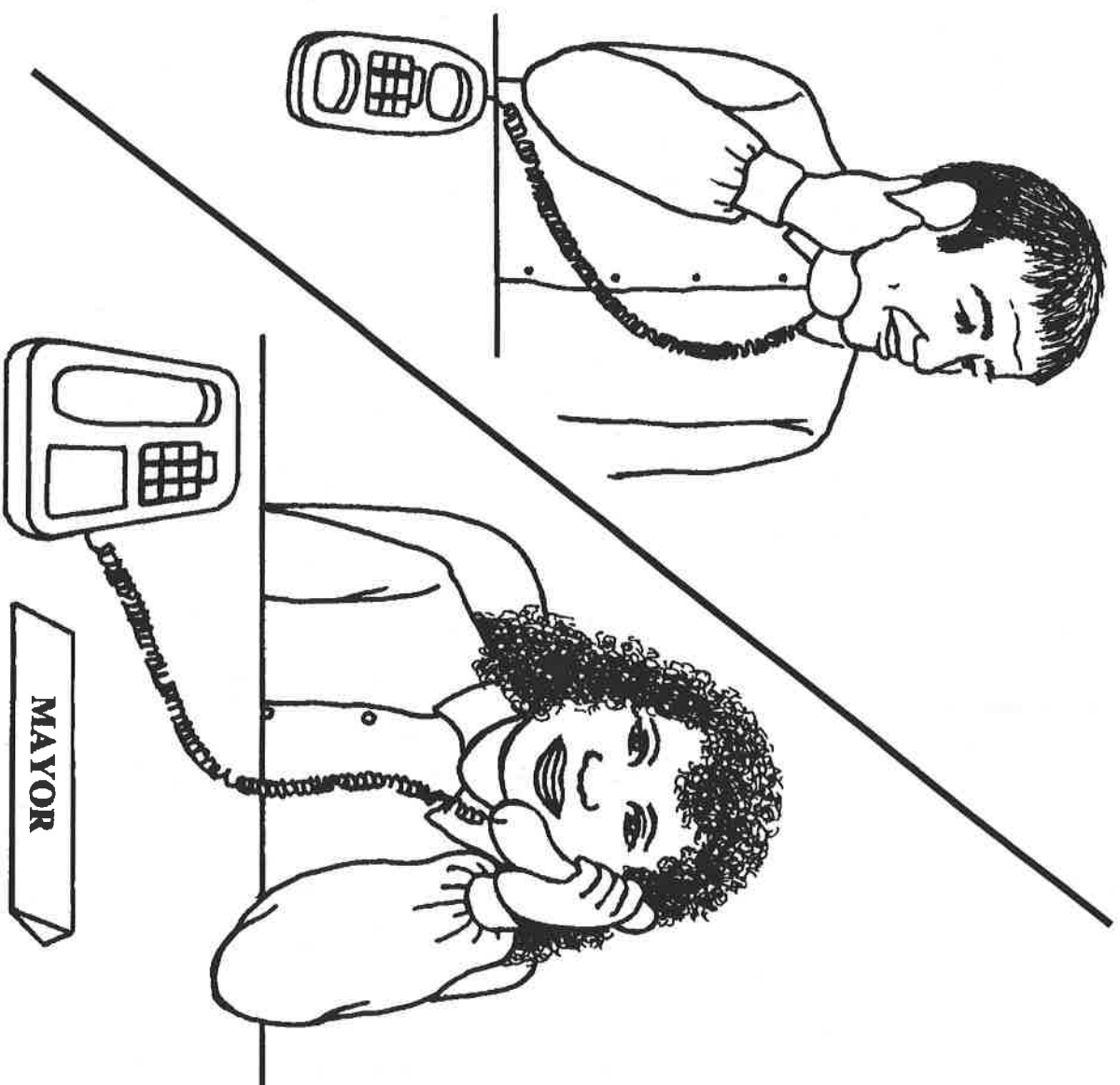

**THE DEMOCRATIC PROCESS:
PARTICIPATING IN STATE AND LOCAL GOVERNMENT**

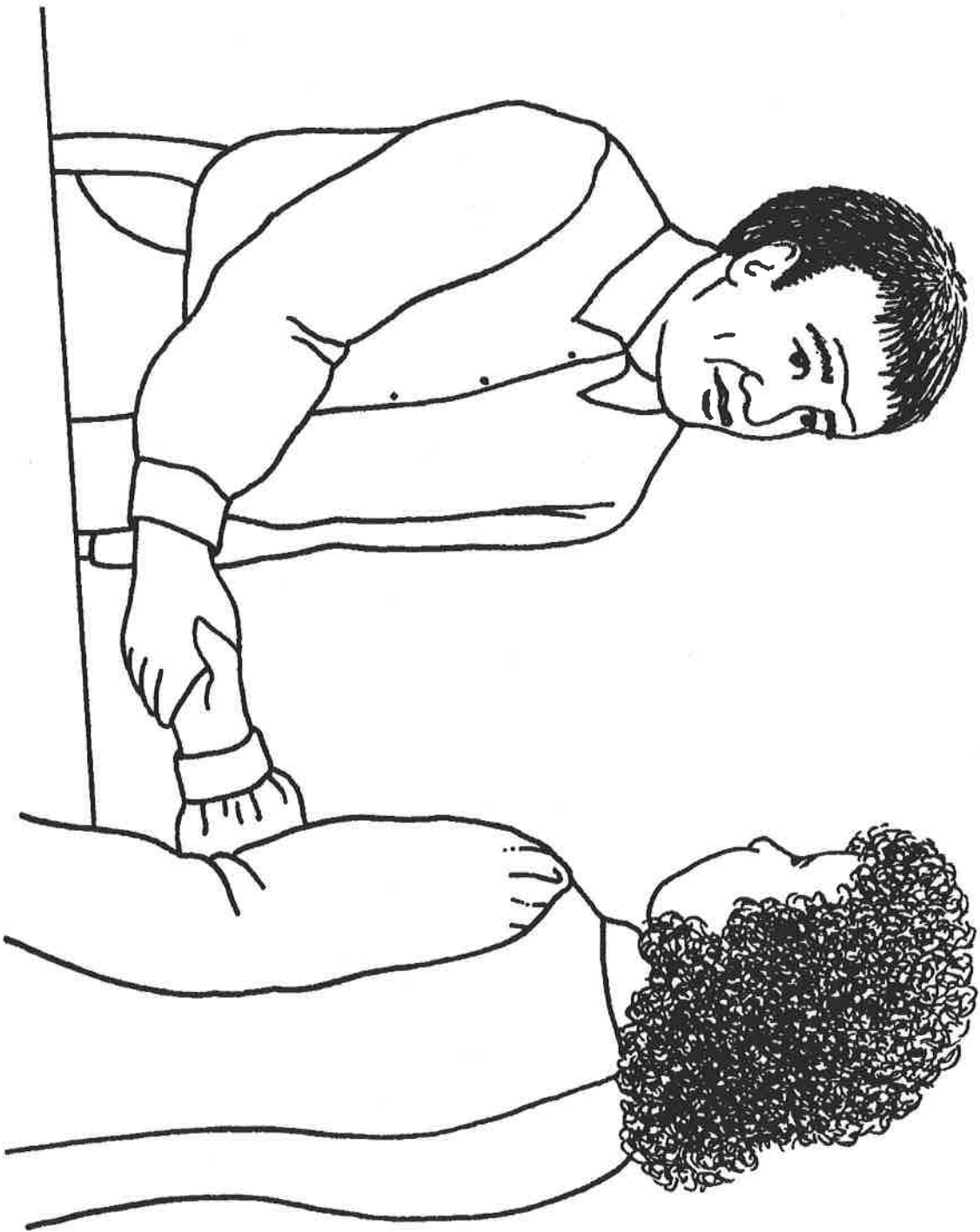

THE DEMOCRATIC PROCESS:
PARTICIPATING IN STATE AND LOCAL GOVERNMENT



**THE DEMOCRATIC PROCESS:
PARTICIPATING IN STATE AND LOCAL GOVERNMENT**

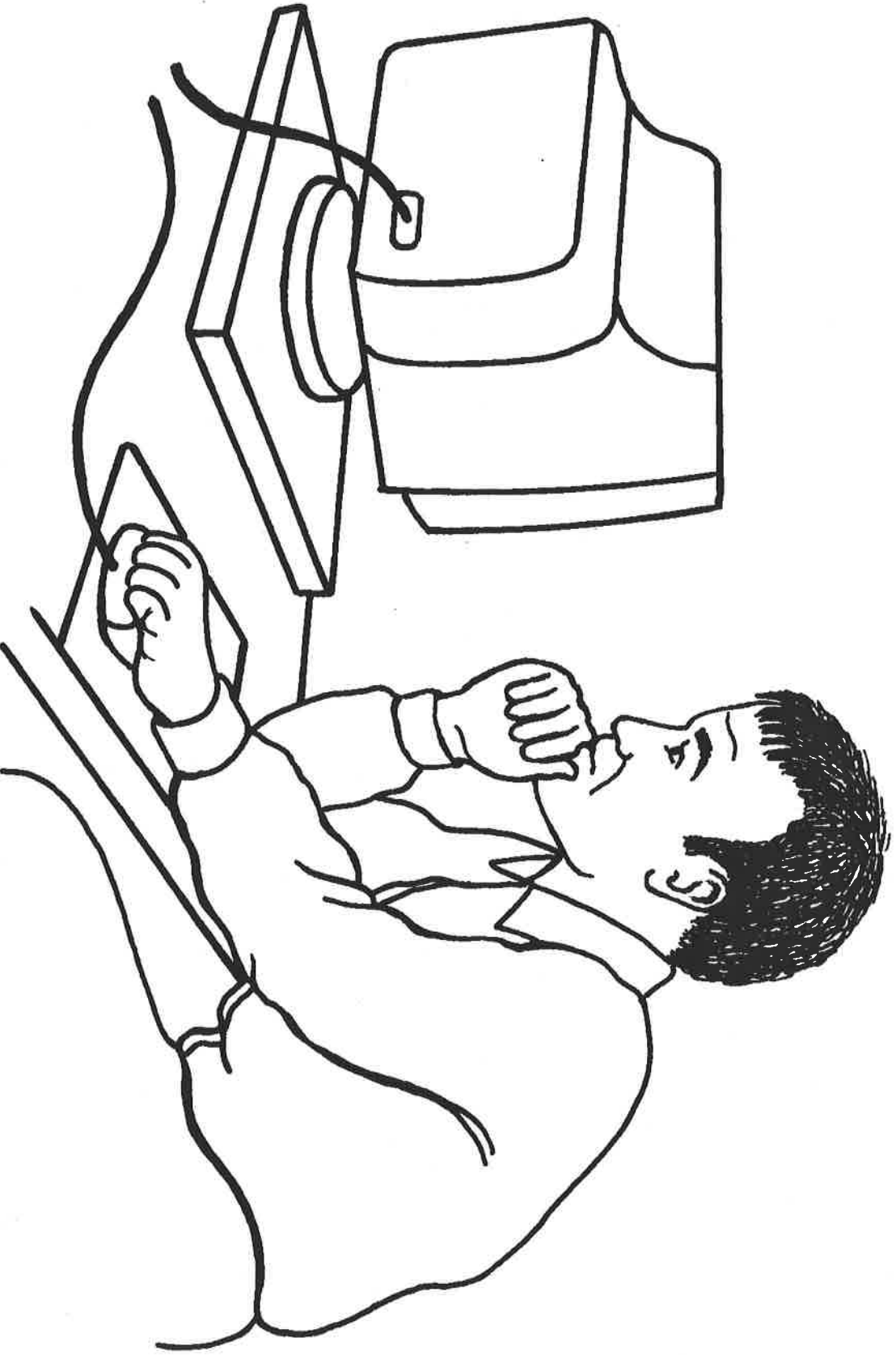

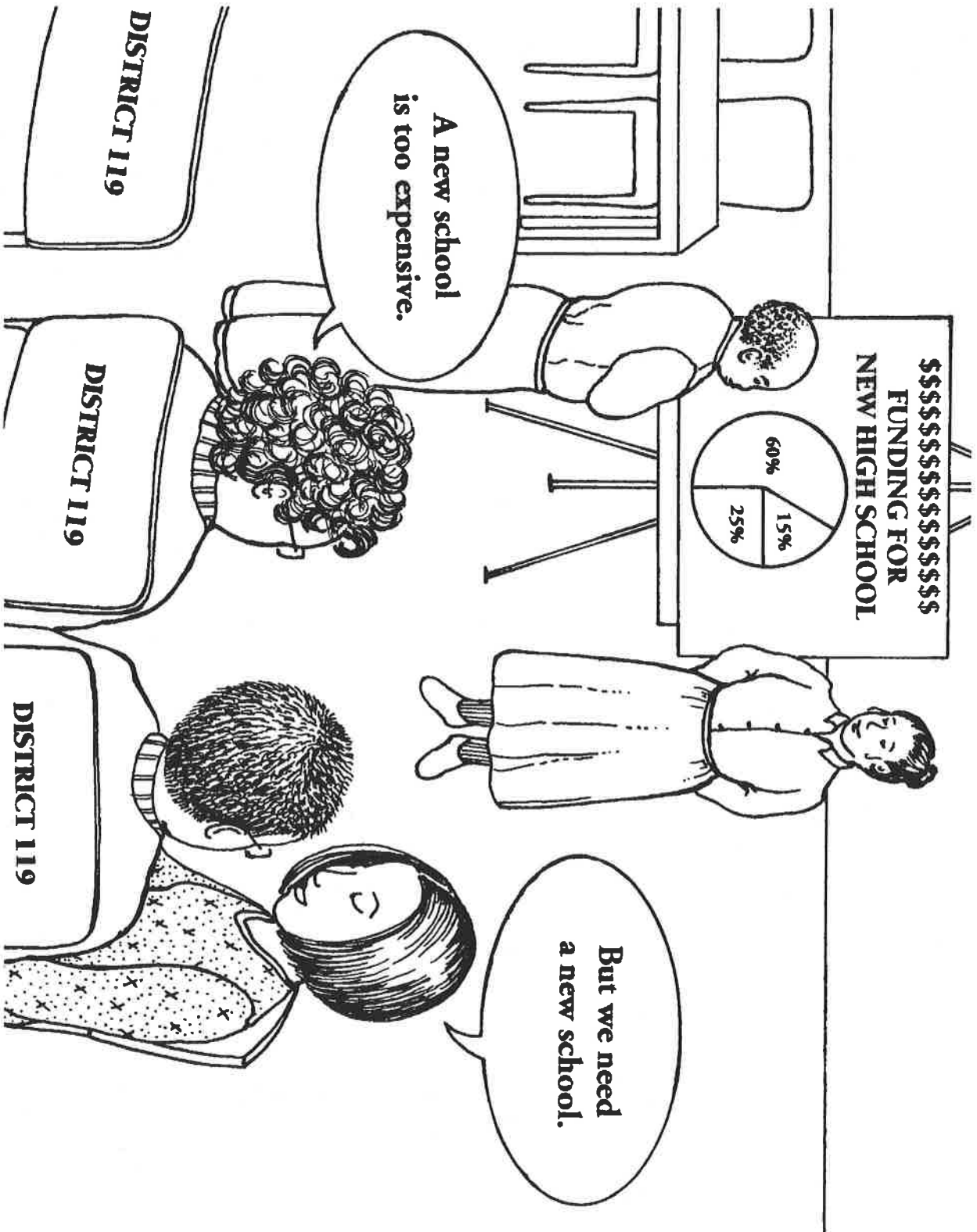

CITY COUNCIL
MEETING

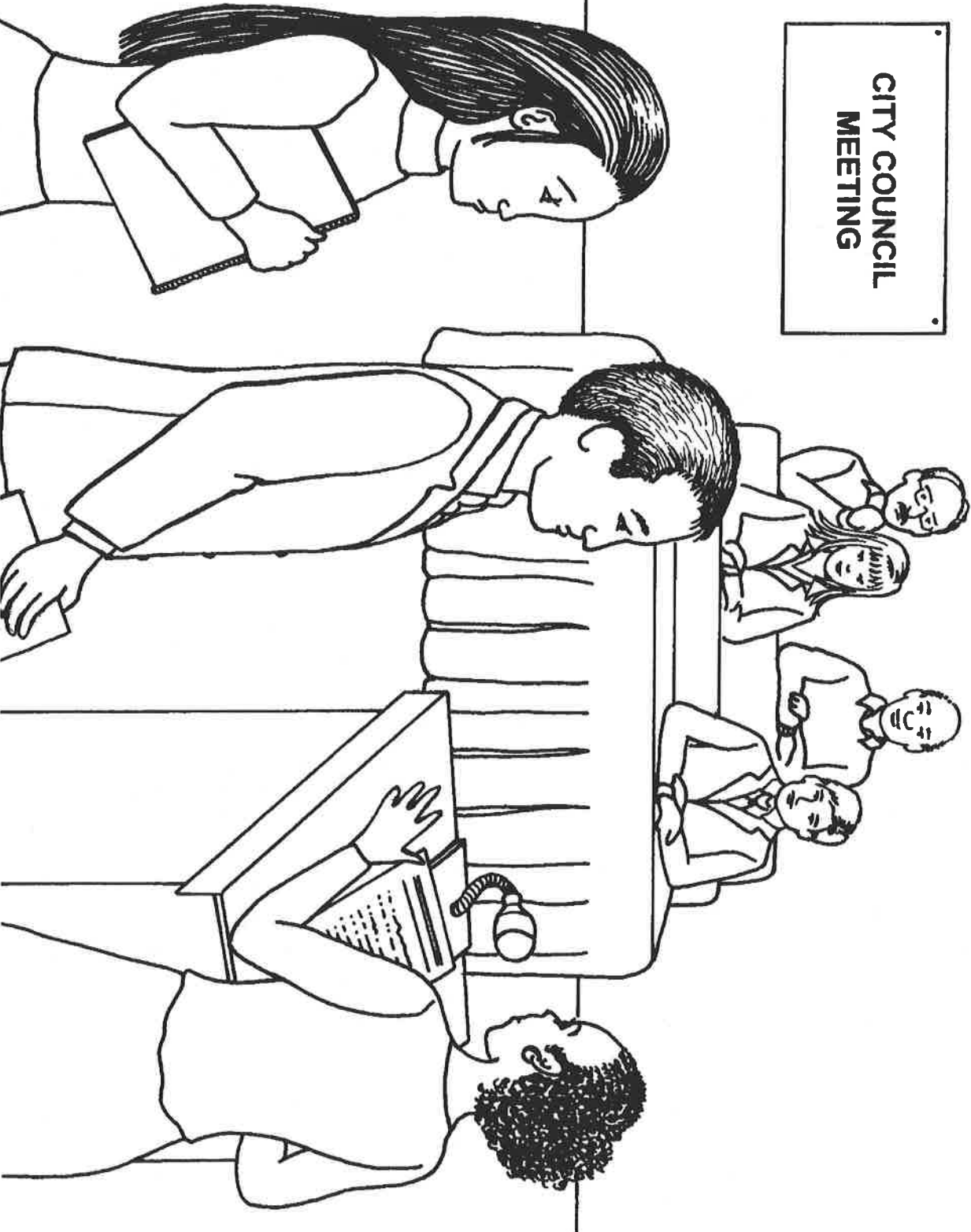

PICTURES FOR LANGUAGE EXPERIENCE

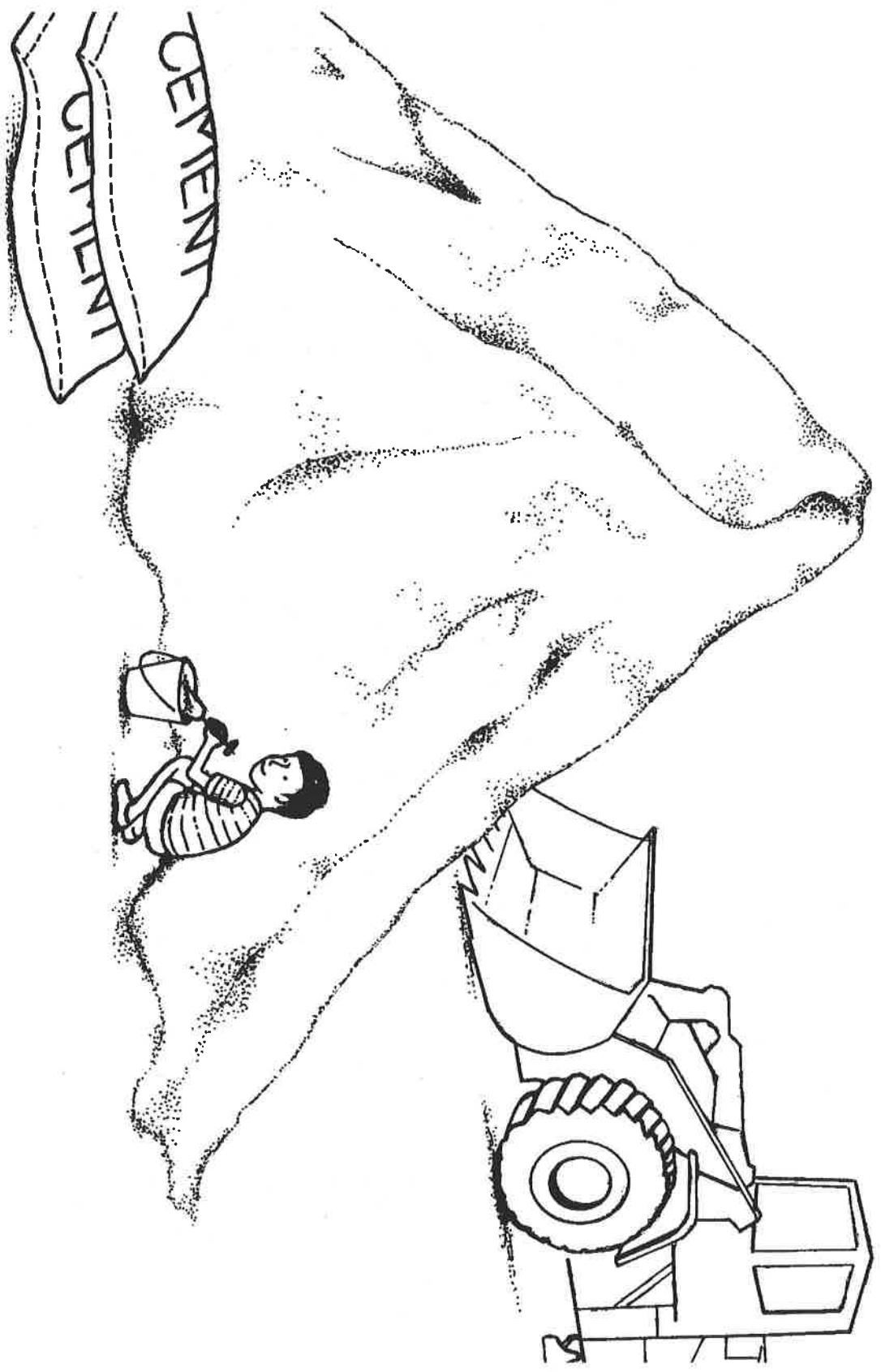

1

PICTURES FOR LANGUAGE EXPERIENCE continued



2

PICTURES FOR LANGUAGE EXPERIENCE continued

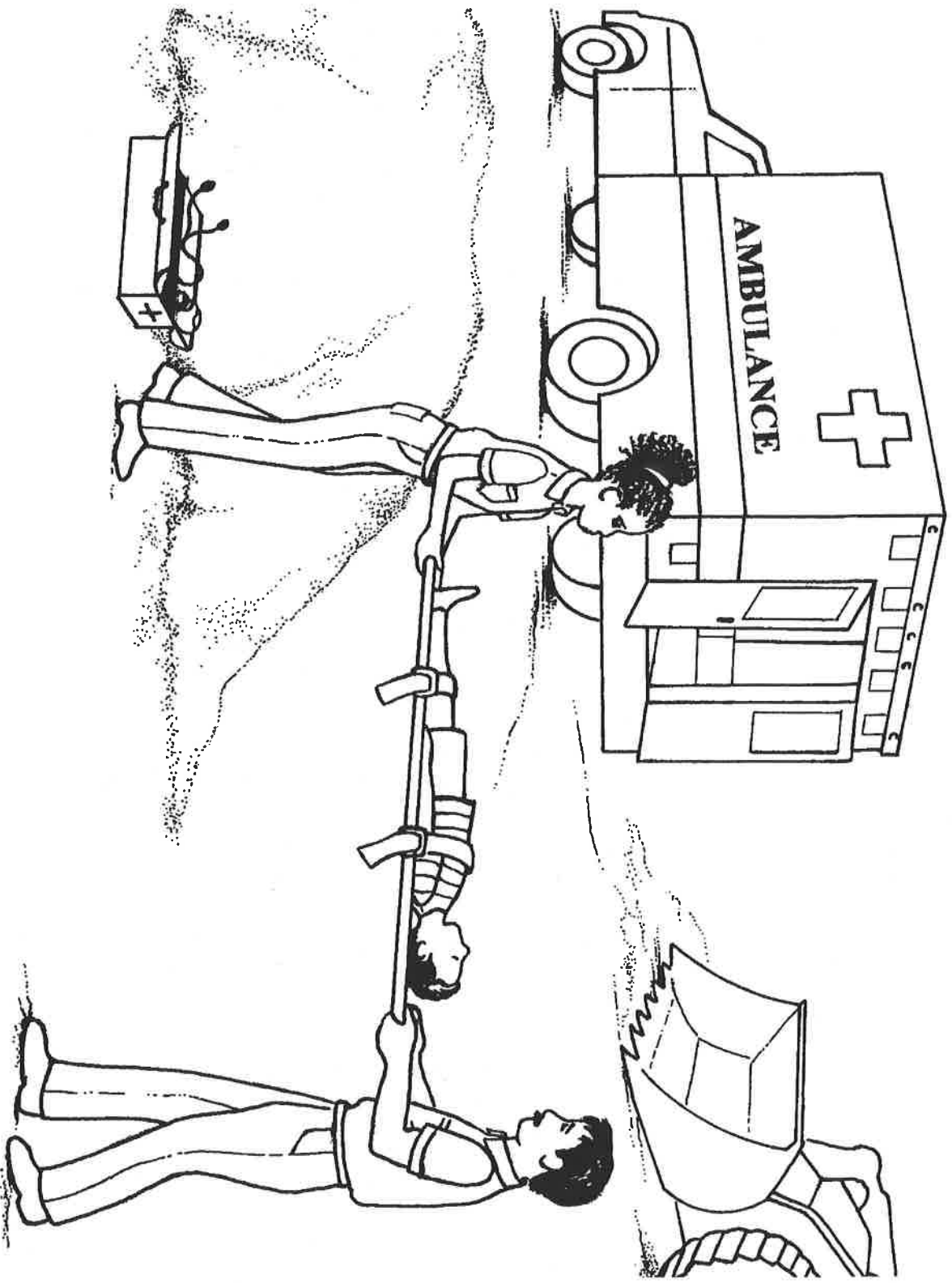

3

PICTURES FOR LANGUAGE EXPERIENCE continued

CITY COUNCIL
MEETING

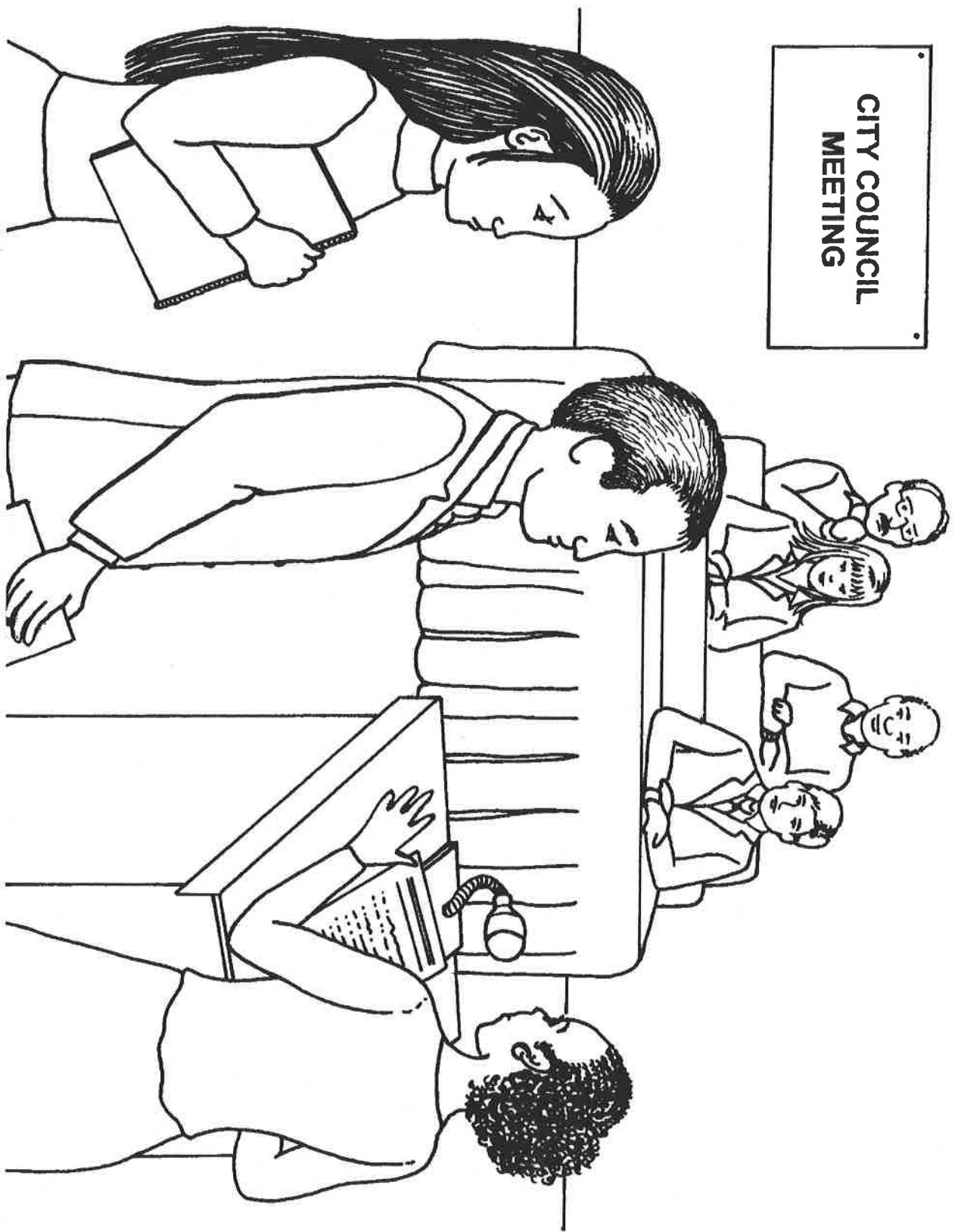

4

PICTURES FOR LANGUAGE EXPERIENCE continued

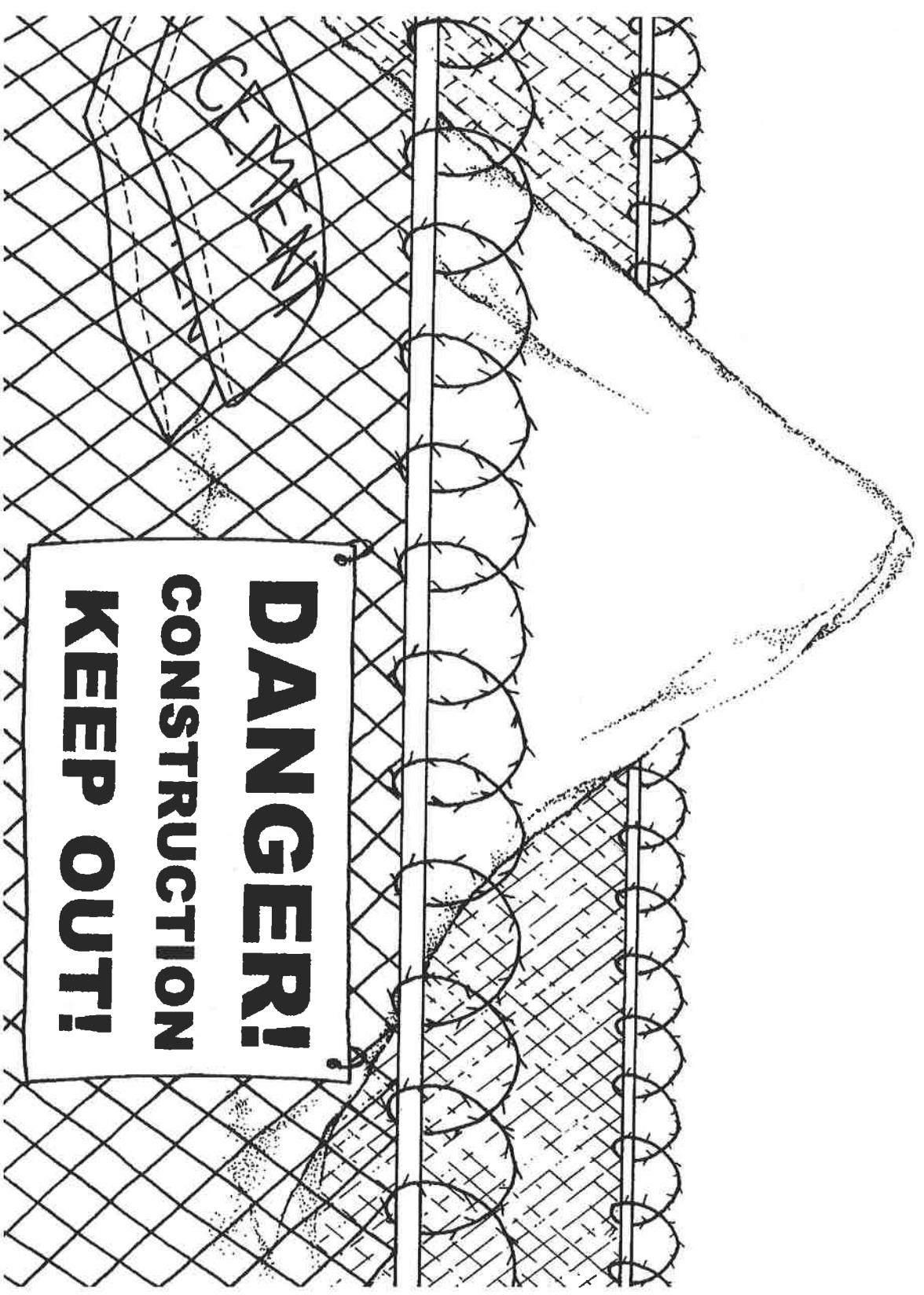

5