

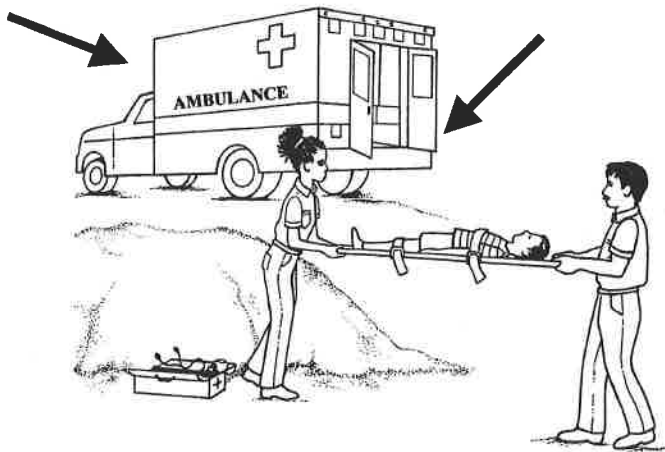

call 911

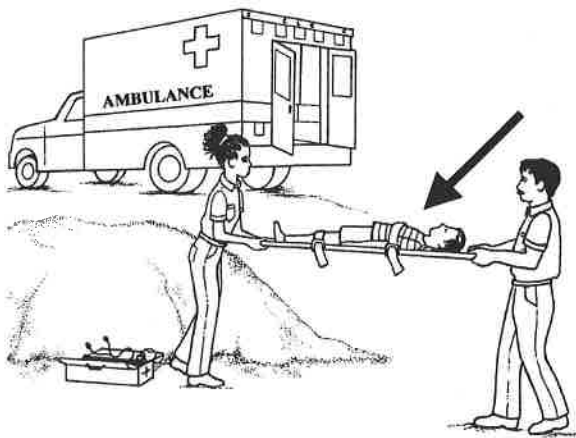

ambulance



injured

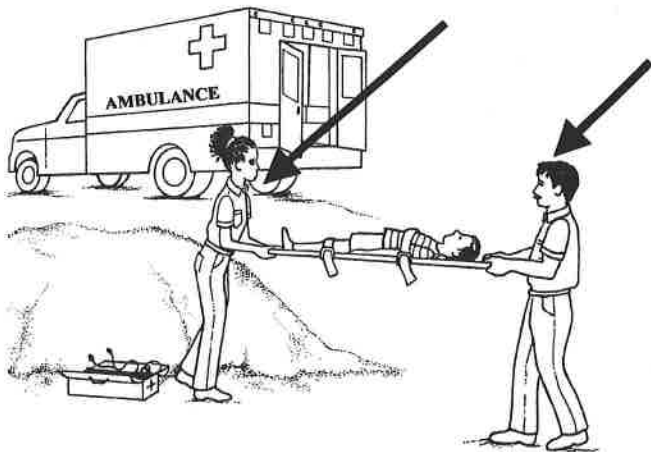

paramedics



police



fire



report stolen property



report damaged property



**infant car seat
(rear facing)**



child car seat

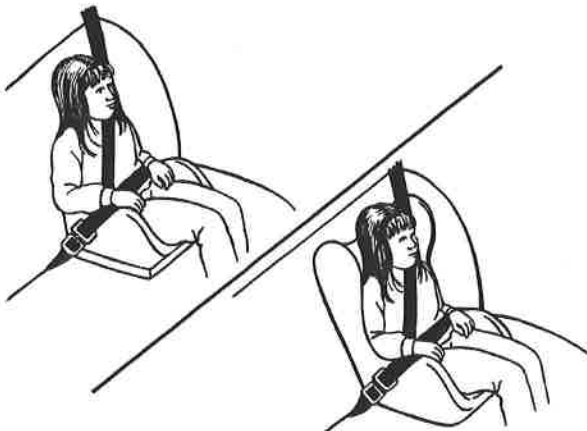

booster seats

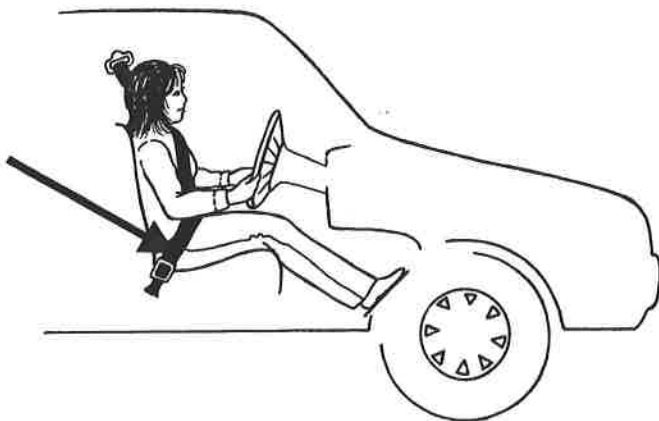

seat belt



airbag



safety ordinance

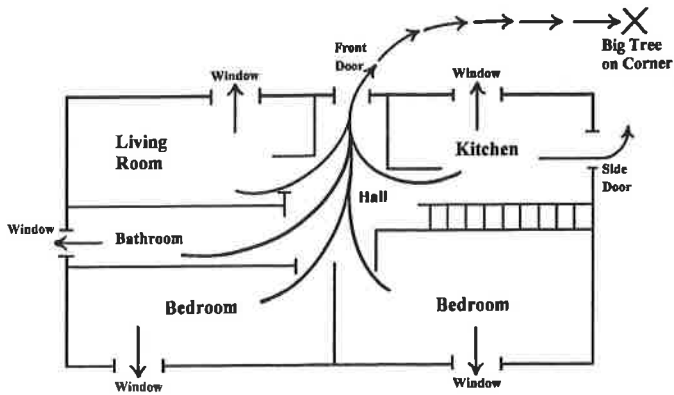

fire escape plan



smoke alarm



fire extinguisher

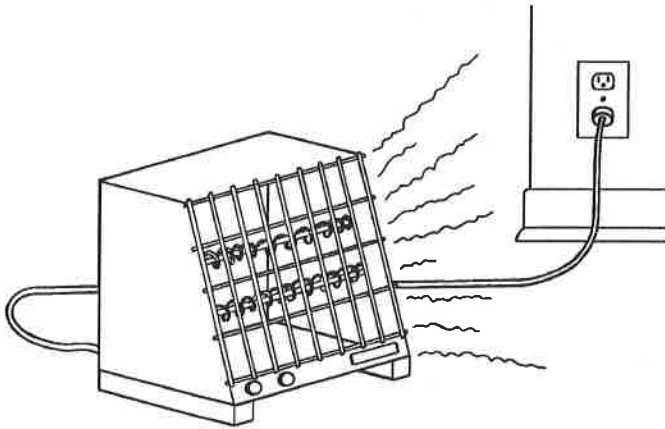

space heater

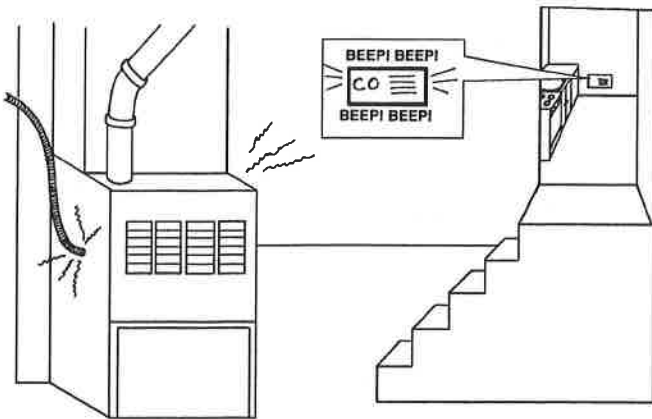

carbon monoxide detector



natural gas

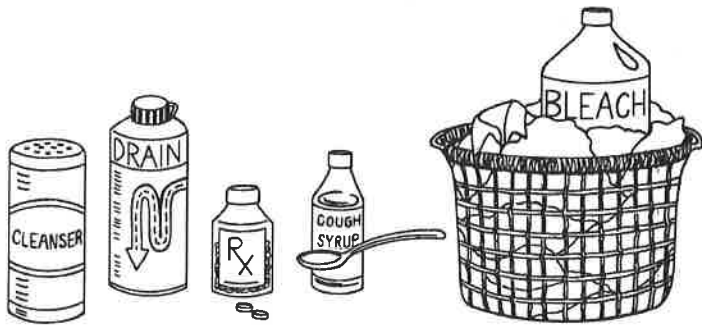

poisons



keep away from children

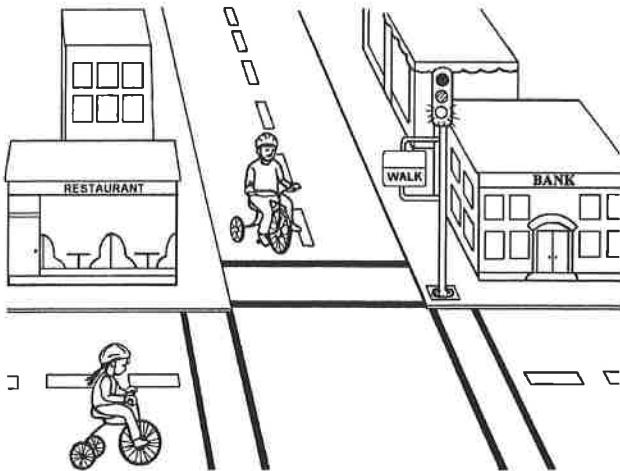

Safety Town

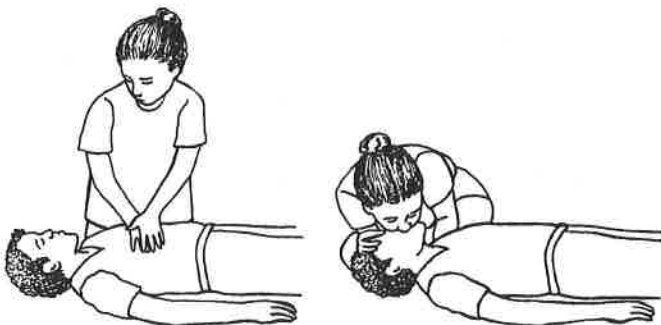

CPR



choking
Heimlich maneuver

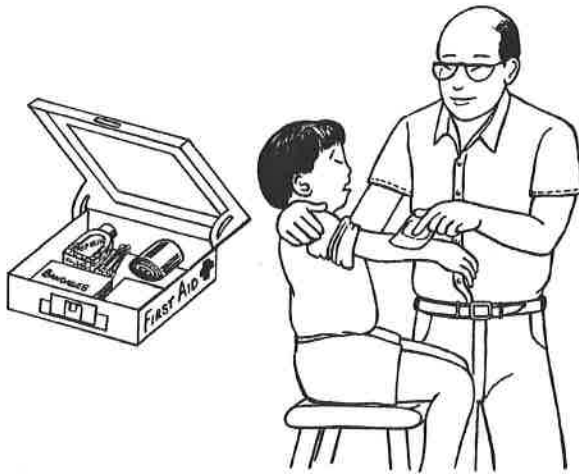

first aid



mugging
robbery

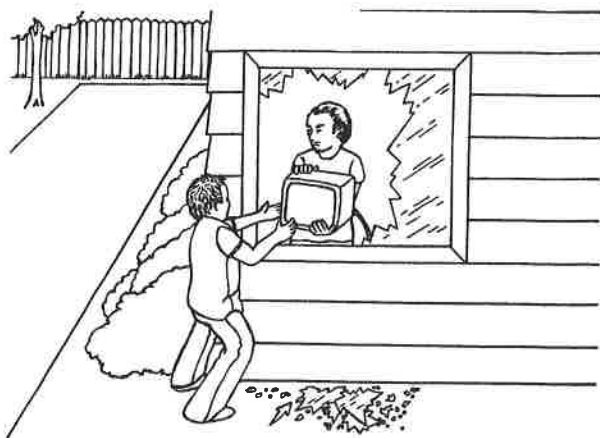

burglary



report suspicious activity



report crimes anonymously

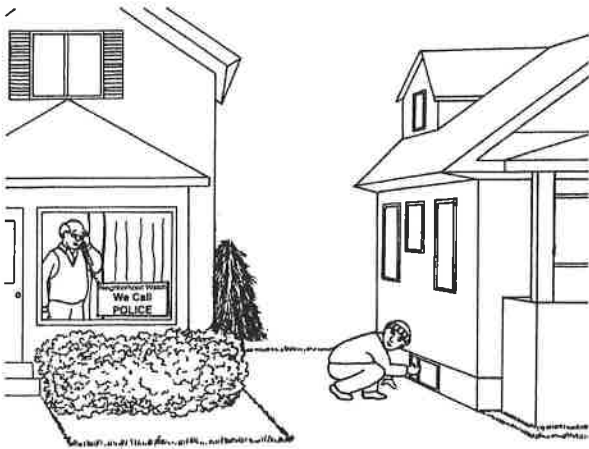

Neighborhood Watch Program